



Norsk

# design tidende

[www.patentstyret.no](http://www.patentstyret.no)

Norsk designtidende er en publikasjon som inneholder kunngjøringer innenfor designområdet

**BESØKSADRESSE**

- ▶ Københavngaten 10

**POSTADRESSE**

- ▶ Postboks 8160 Dep.  
0033 Oslo

**E-POST**

- ▶ [mail@patentstyret.no](mailto:mail@patentstyret.no)

**TELEFON**

- ▶ 22 38 73 00

**TELEFAKS**

- ▶ 22 38 73 01

**INFOSENTERETS TELEFONID**

- ▶ kl. 09.00 - 15.00  
Telefon (+47) 22 38 73 33  
Telefax (+47) 22 38 73 31

## Innholdsfortegnelse

### **Designsaker**

Registrert design .....	side	3
Fornyelse av registreringer .....	»	13

## REGISTRERTE DESIGN

*I henhold til designloven § 18 første ledd i.f. kunngjøres i dag følgende registrerte design.*

Det kan fremsettes krav om at designregistreringen helt eller delvis skal oppheves, jf designloven §§ 25 flg. og designforskriften §§ 26 flg.

Designregistreringen gjelder for den eller de periodene på fem år som søknaden er innlevert for, regnet fra søknadsdagen. Registreringen kan fornyes, jf designloven §§ 23 og 24. Maksimal beskyttelsestid er 25 år. For reservedeler, se unntaket i designloven § 23 annet ledd.

**Reg.nr.:** 77538

Søkn.nr.: 2003 0262

Inngitt.: 2003.05.02

Allm.tilgj: 2003.05.02

Reg.dat0: 2003.08.11

Kunngjort: 2003.09.15

Reg.gjelder til: 2008.05.02



I



I



I



I



I



II



II



II



III



III



III



III



IV



IV



IV



IV

Produkt: I. Kjøkkenmaskin, II. Innsats til kjøkkenmaskin, III. Innsats til kjøkkenmaskin, IV. Innsats til kjøkkenmaskin, klasse 31-00.  
Innehaver: BSH Bosch und Siemens Hausgeräte GmbH, Hochstrasse 17, D-81669 München, DE  
Fullmektig: Onsagers AS, Postboks 6963 St Olavs Plass, 0130 Oslo, NO  
Designer: Rolf Feilim, Jackelbauernfeld 4, D-89312 Günzburg, DE  
Prioritet: 2002.11.01, WO, DM/062267.  
Anmerkning: Det er ikke foretatt supplerende undersøkelse.

**Reg.nr: 77539**

Søkn.nr: 2002 0334

Allm. tilgj.: 2002.05.27

Kunngjort: 2003.09.15

Inngitt: 2002.05.21

Reg.dat: 2003.08.14

Reg. gjelder til: 2007.05.21

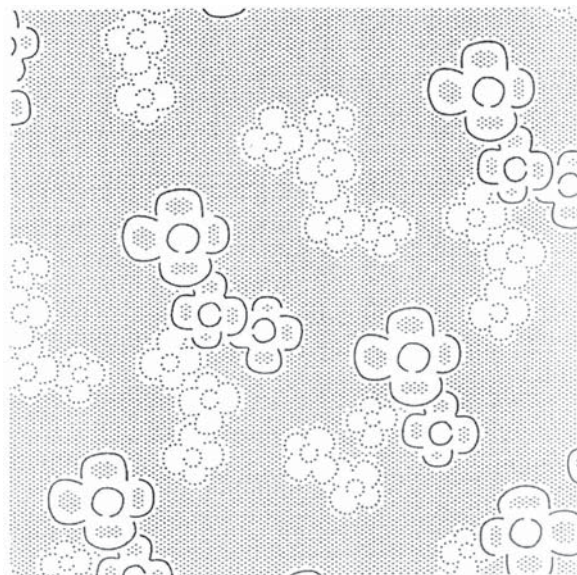

Produkt: Ornamet for tørkepapir, klasse 5-06.  
 Innehaver: Georgia-Pacific France, 11, route Industrielle, F-68320 Kunheim, FR  
 Fullmektig: Oslo Patentkontor AS, Postboks 7007 Majorstua, 0306 Oslo, NO  
 Designer: Francis Bouny, 5, avenue du Maréchal Delattre de Tassigny, F-92100 Boulogne, Michel Basler, 6, rue Vauban, F-68500 Issenheim og Jean-Bernard Kuehn, 4, rue du Bouxhof, F-68630 Bennwihr, alle FR  
 Prioritet: 2001.11.27, FR, nr. 016.901.

**Reg.nr: 77540**

Søkn.nr: 2002 0461

Allm. tilgj.: 2002.07.23

Kunngjort: 2003.09.15

Inngitt: 2002.07.19

Reg.dat: 2003.08.14

Reg. gjelder til: 2007.07.19

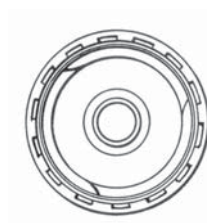
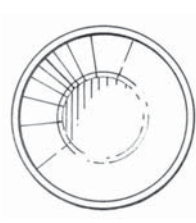
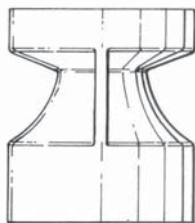
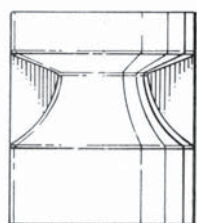
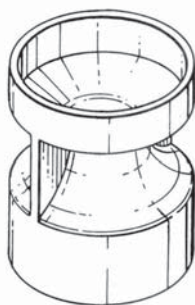

Produkt: Hette til tube, klasse 9-07.  
 Innehaver: GlaxoSmithKline Consumer Healthcare GmbH & Co KG, Bussmatten 1, D-77815 Buehl (Baden), DE  
 Fullmektig: Zacco Norway AS, Postboks 765 Sentrum, 0106 Oslo, NO  
 Designer: Hartmut Mechtold, Muehlstr. 7a, D-75172 Pforzheim og Ralf Welter, Bussmatten 1, D-77815 Buehl, begge DE  
 Prioritet: 2002.01.23, GB, nr. 3.000.937.

**Reg.nr: 77541**

Søkn.nr: 2002 0462

Inngitt: 2002.07.19

Allm. tilgj.: 2002.07.23

Reg.dato: 2003.08.14

Kunngjort: 2003.09.15

Reg. gjelder til: 2007.07.19

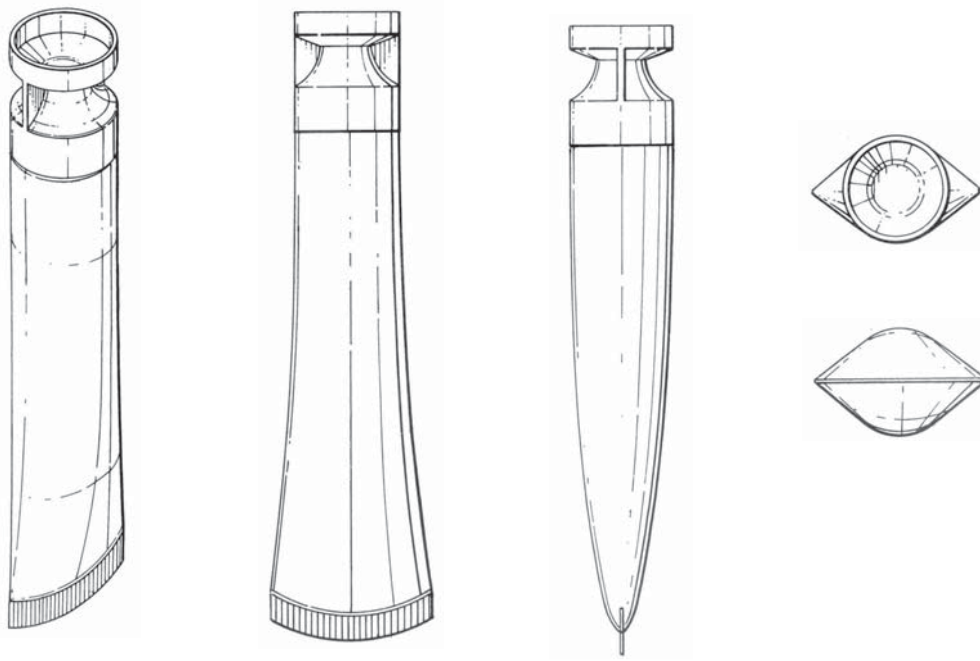

Produkt: Tube, klasse 9-05.

Innehaver: GlaxoSmithKline Consumer Healthcare GmbH &amp; Co KG, Bussmatten 1, D-77815 Buehl (Baden), DE

Fullmektig: Zacco Norway AS, Postboks 765 Sentrum, 0106 Oslo, NO

Designer: Hartmut Mechtold, Muehlstr. 7a, D-75172 Pforzheim og Ralf Welter, Bussmatten 1, D-77815 Buehl (Baden), begge DE

Prioritet: 2002.01.23, GB, nr. 3.000.936.

**Reg.nr: 77542**

Søkn.nr: 2002 0792

Inngitt: 2002.12.20

Allm. tilgj.: 2003.01.04

Reg.dato: 2003.08.14

Kunngjort: 2003.09.15

Reg. gjelder til: 2007.12.20

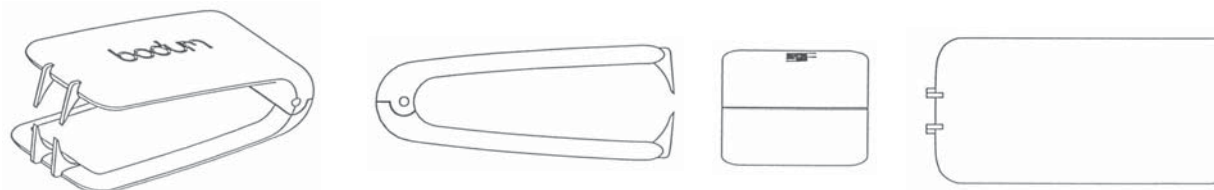

Produkt: Stiftjernere, klasse 19-02.

Innehaver: PI-Design AG, Kantonstrasse, CH-6234 Triengen, CH

Fullmektig: Actio-Lassen AS, Postboks 1880 Nordnes, 5817 Bergen, NO

Designer: Jørgen Bodum. St. Niklausenstrasse 23, CH-6005 St. Niklausen, CH

Prioritet: 2002.07.04, DK, nr. 2002 00536.

**Reg.nr: 77543**

Søkn.nr: 2002 0793

Allm. tilgj.: 2003.01.04

Kunngjort: 2003.09.15

Inngitt: 2002.12.20

Reg.dato: 2003.08.14

Reg. gjelder til: 2007.12.20

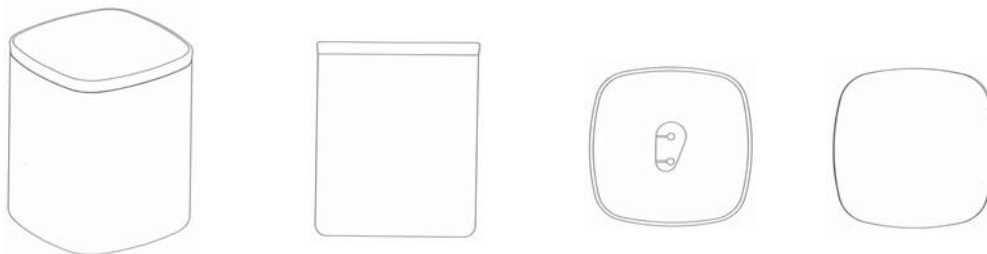

Produkt: Blyantspisser, klasse 19-06.  
Innehaver: PI-Design AG, Kantonstrasse, CH-6234 Triengen, CH  
Fullmektig: Actio-Lassen AS, Postboks 1880 Nordnes, 5817 Bergen, NO  
Designer: Jørgen Bodum, St. Niklausenstrasse 23, CH-6005 St. Niklausen, CH  
Prioritet: 2002.07.04, DK, nr. 2002 00536.

**Reg.nr: 77544**

Søkn.nr: 2002 0794

Allm. tilgj.: 2003.01.04

Kunngjort: 2003.09.15

Inngitt: 2002.12.20

Reg.dato: 2003.08.14

Reg. gjelder til: 2007.12.20

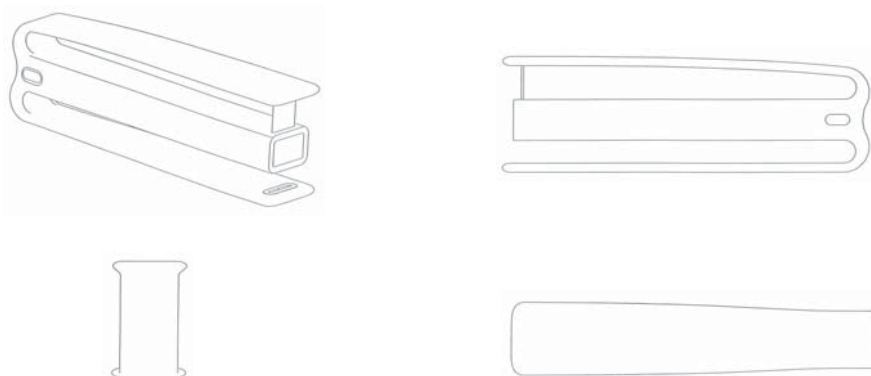

Produkt: Stiftemaskin, klasse 19-02.  
Innehaver: PI-Design AG, Kantonstrasse, CH-6234 Triengen, CH  
Fullmektig: Actio-Lassen AS, Postboks 1880 Nordnes, 5817 Bergen, NO  
Designer: Jørgen Bodum, St. Niklausenstrasse 23, CH-6005 St. Niklausen, CH  
Prioritet: 2002.07.04, DK, nr. 2002 00536.

**Reg.nr: 77545**

Søkn.nr: 2000 0407

Inngitt: 2000.06.14

Allm. tilgj.: 2000.06.17

Reg.dat0: 2003.08.21

Kunngjort: 2003.09.15

Reg. gjelder til: 2005.06.14

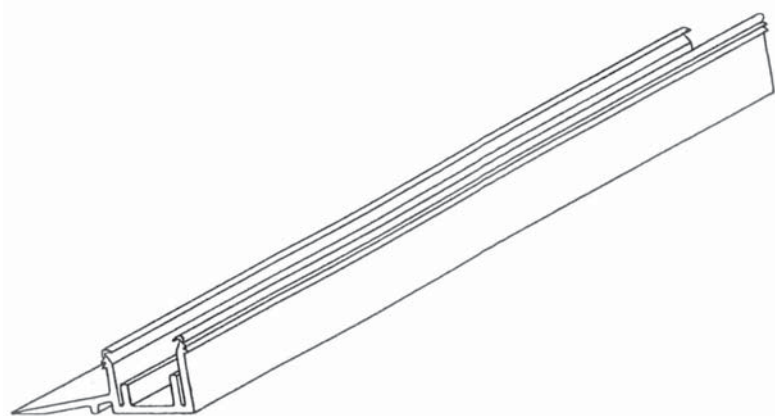

Produkt: Profilskinne for befestigelse av dekklist, avblendinger og lignende, klasse 25-01.  
Innehaver: Franz Neuhofer jr, Haslau 56, A-4893 Zell am Moos, AT  
Fullmektig: Zacco Norway AS, Postboks 765 Sentrum, 0106 Oslo, NO  
Designer: Innehaveren.  
Prioritet: 1999.12.17, AT Mu 4702/99.  
Anmerkning: Registreringen er en variant av reg.nr. 77550.  
Registreringen gjelder samregistrering.

---

**Reg.nr: 77546**

Søkn.nr: 2000 0734

Inngitt: 2000.10.24

Allm. tilgj.: 2001.04.24

Reg.dat0: 2003.08.21

Kunngjort: 2003.09.15

Reg. gjelder til: 2005.10.24

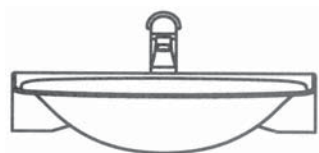

I

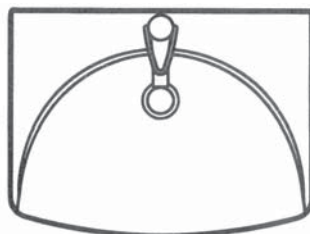

I



I



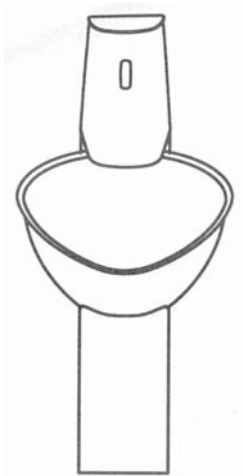

II

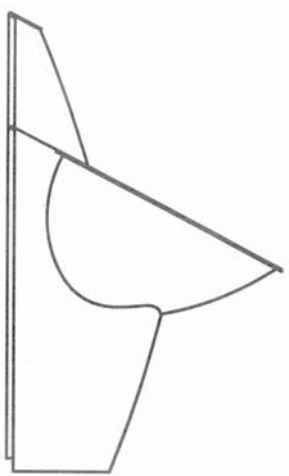

II



II



III

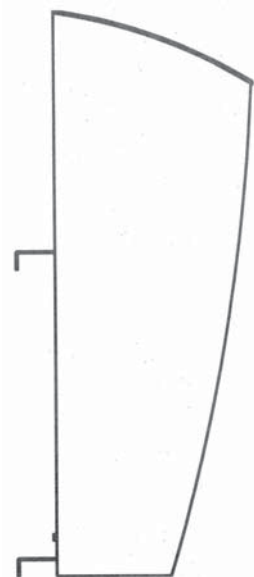

III



III



III



IV



IV

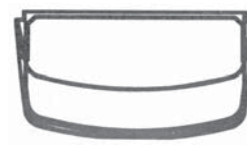

IV

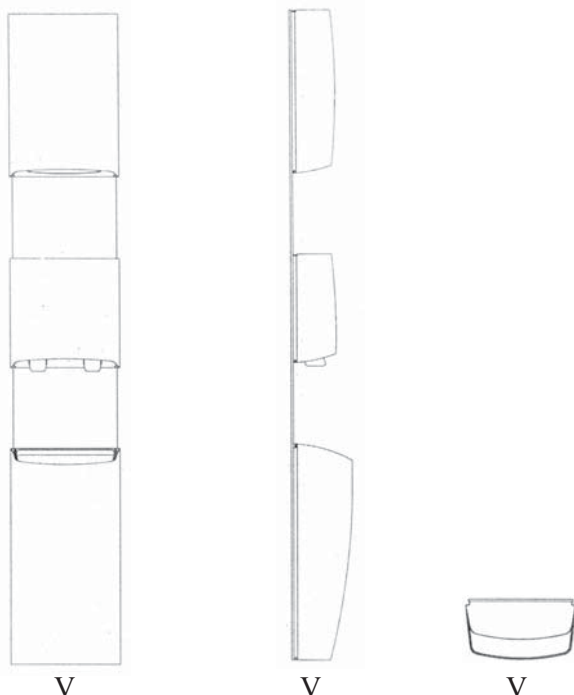

V

V

V

Produkt: I. Servant, II. Urinal, klasse 23-02, III. Skillevegg, klasse 25-02, IV. Avfallsbeholder, klasse 9-09, V. Avfall-, såpe- og papirdispenser, klasse 9-09 og 23-02.  
 Innehaver: Intra AS, Storsand Industriområde, 7563 Malvik, NO  
 Fullmektig: Curo AS, Postboks 38, 7231 Lundamo, NO  
 Designer: Odd Thorsen, Grev Wedels plass 9, 0151 Oslo, NO  
 Anmerkning: Løpenr. I er en variant av løpenr. I i reg.nr 77548.  
 Registreringen gjelder samregistrering.

**Reg.nr: 77547**

Søkn.nr: 2002 0188

Allm. tilgj.: 2001.04.24

Kunngjort: 2003.09.15

Inngitt: 2000.10.24

Reg.dat: 2003.08.21

Reg. gjelder til: 2005.10.24

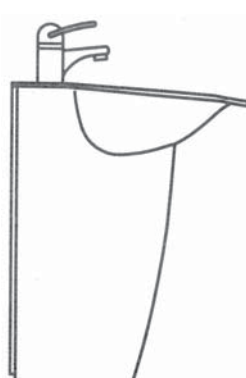
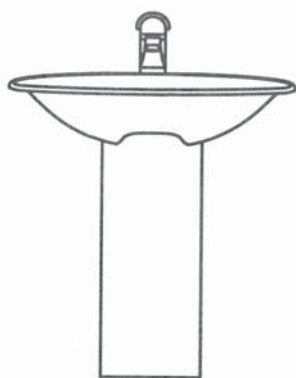

Produkt: Servant, klasse 23-02.  
 Innehaver: Intra AS, Storsand Industriområde, 7563 Malvik, NO  
 Fullmektig: Curo AS, Postboks 38, 7231 Lundamo, NO  
 Designer: Odd Thorsen, Grev Wedels plass 9, 0151 Oslo, NO  
 Anmerkning: Registreringen er en variant av reg.nr. 77549.

**Reg.nr: 77548**

Søkn.nr: 2002 0189

Inngitt: 2000.10.24

Allm. tilgj.: 2001.04.24

Reg.dato: 2003.08.21

Kunngjort: 2003.09.15

Reg. gjelder til: 2005.10.24

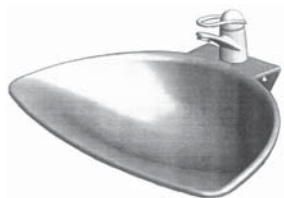

I

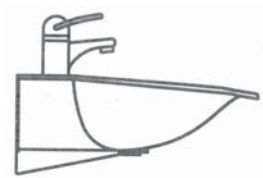

I



I

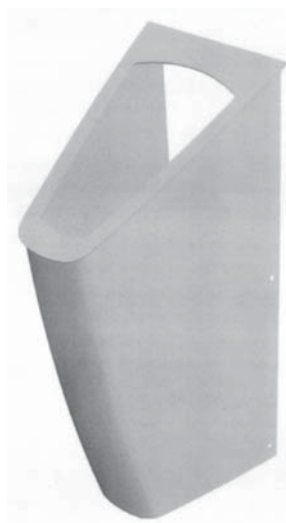

II



II

Produkt: I. Servant, klasse 23-02, II. Avfallsbeholder, klasse 9-09.  
Innehaver: Intra AS, Storsand Industriområde, 7563 Malvik, NO  
Fullmektig: Curo AS, Postboks 38, 7231 Lundamo, NO  
Designer: Odd Thorsen, Grev Wedels plass 9, 0151 Oslo, NO  
Anmerkning: Løpenr. I er en variant av løpenr. I i reg.nr 77546.  
Registreringen gjelder samregistrering.

**Reg.nr: 77549**

Søkn.nr: 2003 0188

Inngitt: 2000.10.24

Allm. tilgj.: 2001.04.24

Reg.dat: 2003.08.21

Kunngjort: 2003.09.15

Reg. gjelder til: 2005.10.24

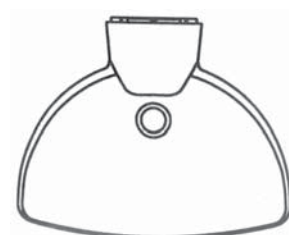
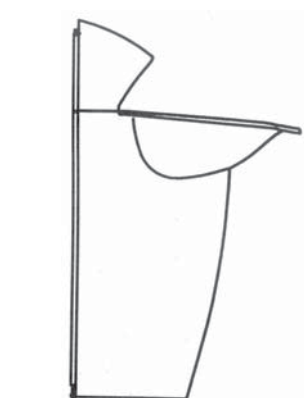
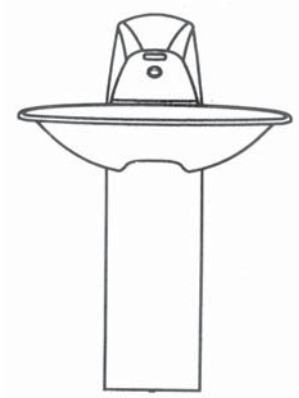

Produkt: Servant, klasse 23-02.  
Innehaver: Intra AS, Storsand Industriområde, 7563 Malvik, NO  
Fullmektig: Curo AS, Postboks 38, 7231 Lundamo, NO  
Designer: Odd Thorsen, Grev Wedels plass 9, 0151 Oslo, NO  
Anmerkning: Registreringen er en variant av reg.nr. 77547.

---

**Reg.nr: 77550**

Søkn.nr: 2003 0199

Inngitt: 2000.06.17

Allm. tilgj.: 2000.06.17

Reg.dat: 2003.08.21

Kunngjort: 2003.09.15

Reg. gjelder til: 2005.06.17

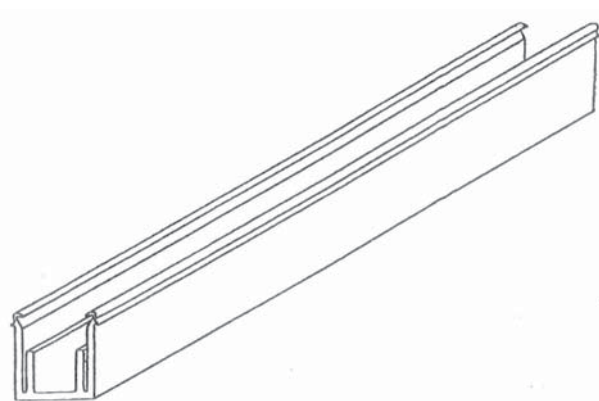

Produkt: Profilskinne for befestigelse av dekklist, avblendinger o.l., klasse 25-01.  
Innehaver: Franz Neuhofer jr, Haslau 56, Zell am Moos, AT  
Fullmektig: Zacco Norway AS, Postboks 765 Sentrum, 0106 Oslo, NO  
Designer: Innehaveren.  
Prioritet: 1999.12.17, AT, nr. Mu 4708/99.  
Anmerkning: Registreringen er en variant av reg.nr. 77545.

## Fornyelse av registreringer

Reg.nr: 68438    Forny et til: 2008.08.09  
Innehaver: Nørholm & Lemming A/S, Nr. 41 Sankt Peders Stræde, DK-1453 København, DK  
Fullmektig: Zacco Norway AS, Postboks 765 Sentrum, 0106 Oslo, NO

Reg.nr: 71627    Forny et til: 2008.08.24  
Innehaver: Perstorp AB, S-284 80 Perstorp, SE  
Fullmektig: Onsagers AS, Postboks 6963 St Olavs Plass, 0130 Oslo, NO

Reg.nr: 71787    Forny et til: 2008.09.22  
Innehaver: Lego A/S, Aastvej 1, DK-7190 Billund, DK  
Fullmektig: Tandbergs Patentkontor AS, Postboks 7085 Majorstua, 0306 Oslo, NO

Reg.nr: 71937    Forny et til: 2009.02.07  
Innehaver: Smitdesign BV, Industrieweg 20, NL-3958 VR Amerongen, NL  
Fullmektig: Oslo Patentkontor AS, Postboks 7007 Majorstua, 0306 Oslo, NO

Reg.nr: 72471    Forny et til: 2008.09.22  
Innehaver: Lego A/S, Aastvej 1, DK-7190 Billund, DK  
Fullmektig: Tandbergs Patentkontor AS, Postboks 7085 Majorstua, 0306 Oslo, NO

Reg.nr: 72472    Forny et til: 2008.09.22  
Innehaver: Lego A/S, Aastvej 1, DK-7190 Billund, DK  
Fullmektig: Tandbergs Patentkontor AS, Postboks 7085 Majorstua, 0306 Oslo, NO

Reg.nr: 74622    Forny et til: 2008.08.26  
Innehaver: Dolomite Svenska AB, V. Götgatan 5, S-334 21 Anderstorp, SE  
Fullmektig: Awapatent AB, Box 5117, S-200 71 Malmö, SE

Reg.nr: 74695    Forny et til: 2008.08.14  
Innehaver: Dooria Kungsäter AB, Prästgårdsvägen 81, S-519 92 Kungsäter, SE  
Fullmektig: Tandbergs Patentkontor AS, Postboks 7085 Majorstua, 0306 Oslo, NO

Reg.nr: 74696    Forny et til: 2008.08.14  
Innehaver: Dooria Kungsäter AB, Prästgårdsvägen 81, S-519 92 Kungsäter, SE  
Fullmektig: Tandbergs Patentkontor AS, Postboks 7085 Majorstua, 0306 Oslo, NO

Reg.nr: 74915    Forny et til: 2008.08.20  
Innehaver: Perstorp Plastic Systems AB, S-284 80 Perstorp, SE  
Fullmektig: Onsagers AS, Postboks 6963 St Olavs Plass, 0130 Oslo, NO

Reg.nr: 74977                                  Fornyhet til: 2008.08.20  
Innehaver: Perstorp Plastic Systems AB, S-284 80 Perstorp, SE  
Fullmektig: Onsagers AS, Postboks 6963 St Olavs Plass, 0130 Oslo, NO

Reg.nr: 75005                                  Fornyhet til: 2008.10.21  
Innehaver: Dorma GmbH + Co KG, P.O.Box 4009, DE-58247 Ennepetal, DE  
Fullmektig: Protector Intellectual Property Consultants AS, Postboks 5074 Majorstua, 0301 Oslo, NO

Reg.nr: 75019                                  Fornyhet til: 2008.08.20  
Innehaver: Unilever NV, Weena 455, NL-3013 AL Rotterdam, NL  
Fullmektig: Zacco Norway AS, Postboks 765 Sentrum, 0106 Oslo, NO

Reg.nr: 75020                                  Fornyhet til: 2008.08.20  
Innehaver: Unilever NV, Weena 455, NL-3013 AL Rotterdam, NL  
Fullmektig: Zacco Norway AS, Postboks 765 Sentrum, 0106 Oslo, NO

Reg.nr: 75028                                  Fornyhet til: 2008.09.07  
Innehaver: Unilever NV, Weena 455, NL-3013 AL Rotterdam, NL  
Fullmektig: Zacco Norway AS, Postboks 765 Sentrum, 0106 Oslo, NO

Reg.nr: 75060                                  Fornyhet til: 2008.08.20  
Innehaver: Unilever NV, Weena 455, NL-3013 AL Rotterdam, NL  
Fullmektig: Zacco Norway AS, Postboks 765 Sentrum, 0106 Oslo, NO

Reg.nr: 76741                                  Fornyhet til: 2008.09.28  
Innehaver: Nokia Multimedia Terminals OY, Keilalahdentie 4, SF-02150 Esbo, FI  
Fullmektig: Norsk Patentbyrå, Postboks 2911 Solli, 0204 Oslo, NO