



Norsk

design tidende

www.patentstyret.no

Norsk designtidende er en publikasjon som inneholder kunngjøringer innenfor designområdet

BESØKSADRESSE

- ▶ Københavngaten 10

POSTADRESSE

- ▶ Postboks 8160 Dep.
0033 Oslo

E-POST

- ▶ mail@patentstyret.no

TELEFON

- ▶ 22 38 73 00

TELEFAKS

- ▶ 22 38 73 01

INFOSENTERETS TELEFONID

- ▶ kl. 09.00 - 15.00
Telefon (+47) 22 38 73 33
Telefax (+47) 22 38 73 31

Innholdsfortegnelse

Designsaker

Registrerte design	side	3
Fornyelse av registreringer	»	17

REGISTRERT DESIGN

I henhold til designloven § 18 første ledd i.f. kunngjøres i dag følgende registrerte design.

Det kan fremsettes krav om at designregistreringen helt eller delvis skal oppheves, jf designloven §§ 25 flg. og designforskriften §§ 26 flg.

Designregistreringen gjelder for den eller de periodene på fem år som søknaden er innlevert for, regnet fra søknadsdagen. Registreringen kan fornyes, jf designloven §§ 23 og 24. Maksimal beskyttelsestid er 25 år. For reservedeler, se unntaket i designloven § 23 annet ledd.

Reg.nr: 77579

Søkn.nr: 2003 0280

Inngitt: 2003.05.12

Allm. tilgj.: 2003.05.12

Reg.dat: 2003.10.09

Kunngjort: 2003.11.10

Reg. gjelder til: 2008.05.12

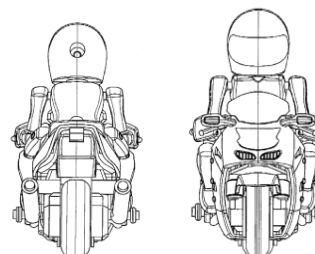
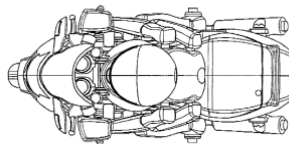
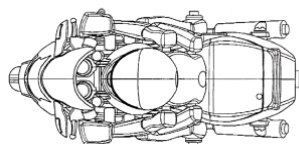
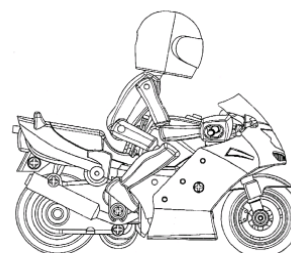
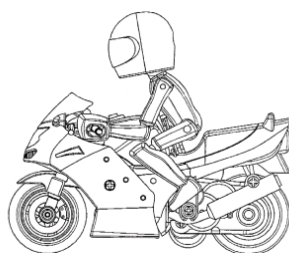
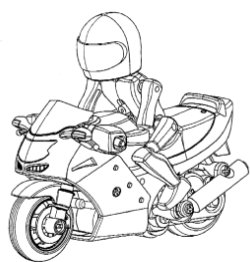

Produkt: Fjernstyrt leketøysmotorsykkkel, klasse 21-01.
Innehaver: Nikko Co Ltd., 15-15 Kameari 5-chome, Katsushika-ku, Tokyo, 125-0061, JP
Fullmektig: Tandbergs Patentkontor AS, Postboks 7085 M, 0306 Oslo, NO
Designer: Kenji Mukaida, c/o Nikko Co Ltd., 15-15, Kameari 5-chome, Katsushika-ku, Tokyo, 125-0061, JP
Anmerkning: Det er ikke foretatt supplerende undersøkelse.

Reg.nr: 77580

Søkn.nr: 2002 0301

Allm. tilgj.: 2002.05.12

Kunngjort: 2003.11.10

Inngitt: 2002.05.06

Reg.dat: 2003.10.09

Reg. gjelder til: 2007.05.06

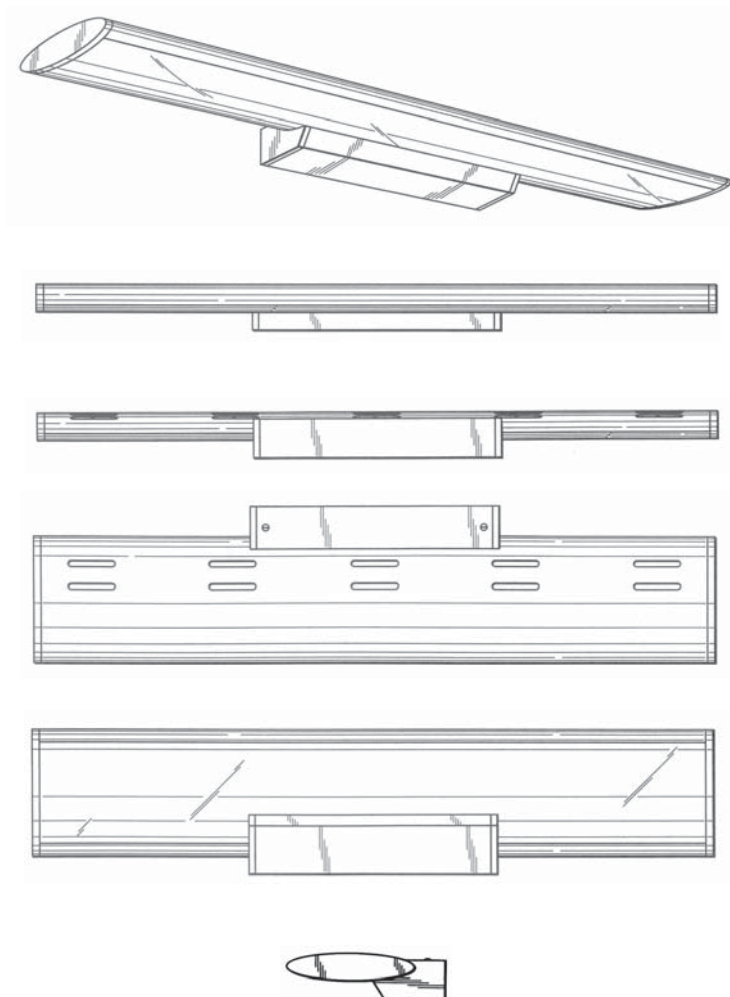

Produkt: Vegglampe, klasse 26-05.
Innehaver: Derungs Licht AG, Hofmattstrasse 12, CH-9202 Gossau, CH
Fullmektig: Zacco Norway AS, Postboks 765 Sentrum, 0106 Oslo, NO
Designer: Erwin Weitgasser, Morzgerstr 4, AT-5020 Salzburg, AT
Prioritet: 2001.11.12, WO, nr DM/058476.

Reg.nr: 77581

Søkn.nr: 2002 0382

Inngitt: 2002.06.12

Allm. tilgj.: 2002.06.12

Reg.dat: 2003.10.09

Kunngjort: 2003.11.10

Reg. gjelder til: 2007.06.12

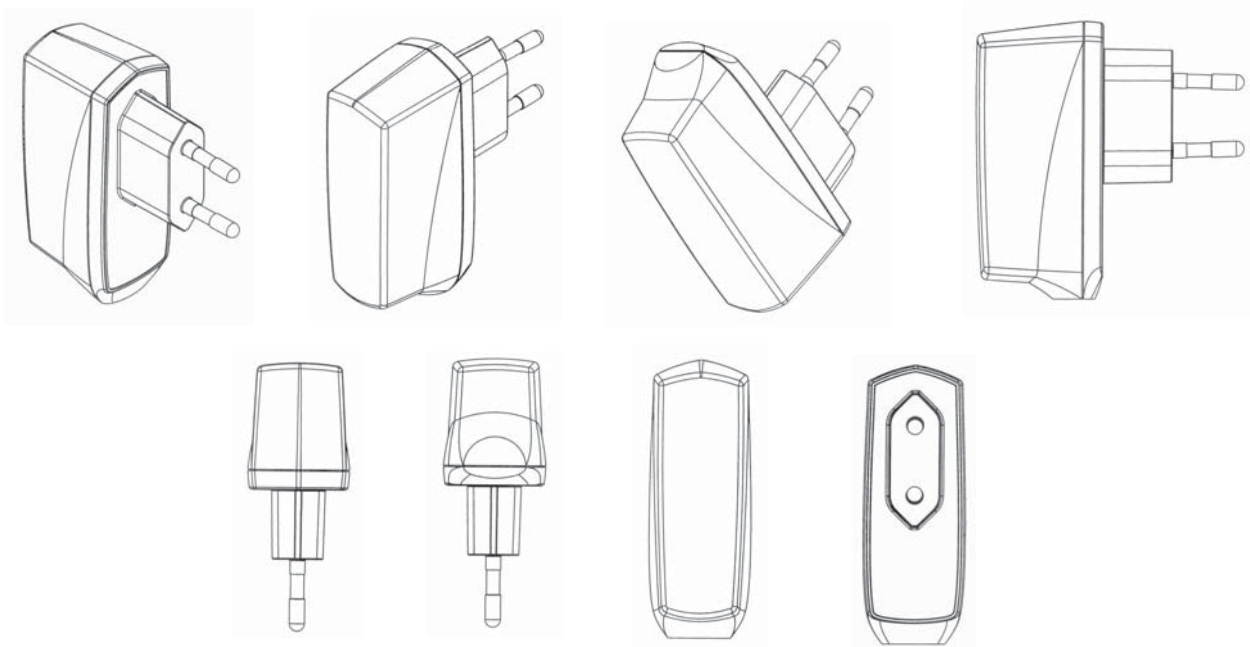

Produkt: Reiselader, klasse 13-02.
 Innehaver: Nokia Corp, Keilalahdentie 4, SF-02150 Esbo, FI
 Fullmektig: AS Bergen Patentkontor, Postboks 1998 Nordnes, 5817 Bergen, NO
 Designer: Heli Säde, Liitoskatu 11, SF-24260 Salo, FI og Eero Kankainen, 50 C Settle Street, London E1 1 JP, England, GB
 Prioritet: 2001.12.12, FI, nr M20010806.

Reg.nr: 77582

Søkn.nr: 2002 0386

Inngitt: 2002.06.13

Allm. tilgj.: 2002.07.28

Reg.dat: 2003.10.09

Kunngjort: 2003.11.10

Reg. gjelder til: 2007.06.13

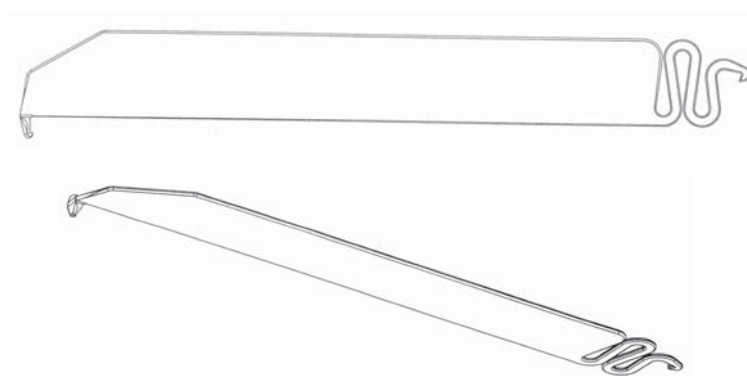

Produkt: Vareskille for hyller og stativ for oppbevaringsformål, klasse 6-04 og 6-06.
 Innehaver: Sintek International AB, Söder Mälarstrand 71, S-118 25 Stockholm, SE
 Fullmektig: Actio-Lassen AS, Postboks 1880 Nordnes, 5817 Bergen, NO
 Designer: Magnus Lingvall, Svarvargatan 20, S-112 49 Stockholm, SE
 Prioritet: 2002.01.28, SE, nr 02-0139.

Reg.nr: 77583

Søkn.nr: 2002 0546

Allm. tilgj.: 2002.08.30

Kunngjort: 2003.11.10

Inngitt: 2002.08.30

Reg.dat: 2003.10.09

Reg. gjelder til: 2007.08.30



Produkt: Veske, klasse 3-01.

Innehaver: Mathias Molden, Torfæus gate 6, 4009 Stavanger og Harald Sævareid, Gravarsbråtet 23, 4327 Sandnes, begge NO

Designer: Mathias Molden, Torfæus gate 6, 4009 Stavanger og Harald Sævareid, Gravarsbråtet 23, 4327 Sandnes, begge NO

Reg.nr: 77584

Søkn.nr: 2002 0723

Allm. tilgj.: 2002.12.04

Kunngjort: 2003.11.10

Inngitt: 2002.11.20

Reg.dat: 2003.10.09

Reg. gjelder til: 2007.11.20

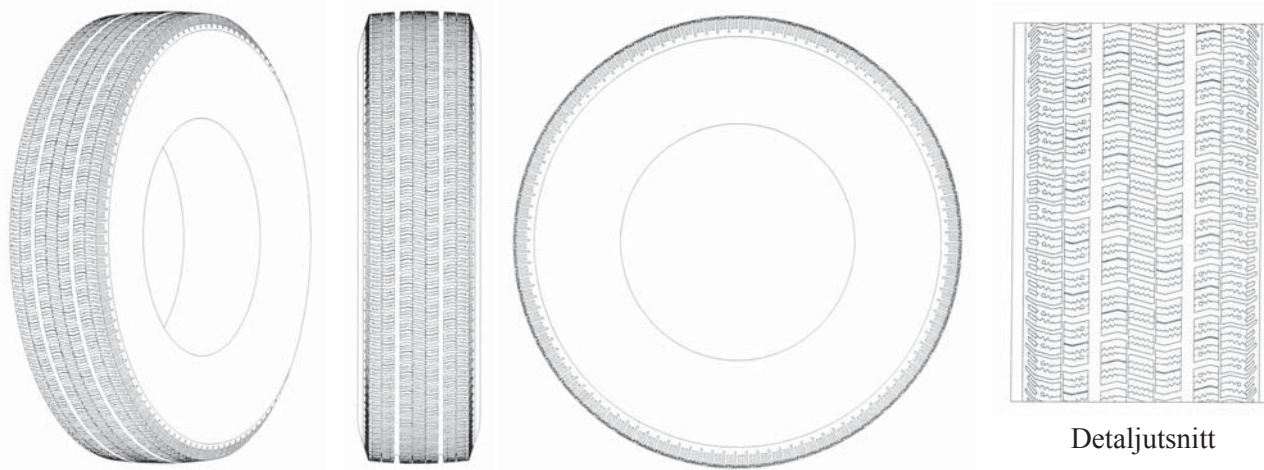

Produkt: Dekk for kjøretøy, klasse 12-15.

Innehaver: The Goodyear Tire & Rubber Co, 1144 East Market Street, Akron, OH 44316-0001, US

Fullmektig: Tandbergs Patentkontor AS, Postboks 7085 Majorstua, 0306 Oslo, NO

Designer: Gerard Durand, 57, Route de Holzem, L-8232 Mamer, LU, Jean-Francois Cazin-Bourguignon, 14, Rue Robert Kruger, F-57390 Audun-le-Tiche, FR og Michel Pierre Charles Robert, 11, Viree du Renard, B-6640 Sibret, BE

Prioritet: 2002.06.04, US, nr 29/161.821.

Reg.nr: 77585

Søkn.nr: 2002 0727

Allm. tilgj.: 2002.11.29

Kunngjort: 2003.11.10

Inngitt: 2002.11.21

Reg.dato: 2003.10.09

Reg. gjelder til: 2007.11.21

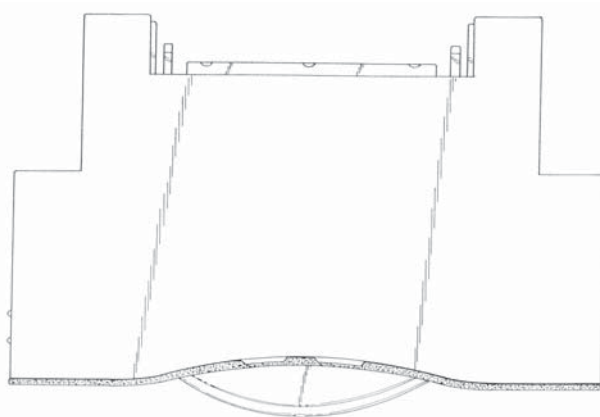
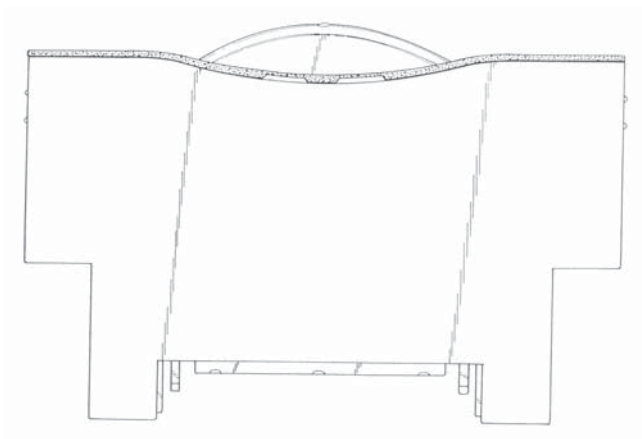
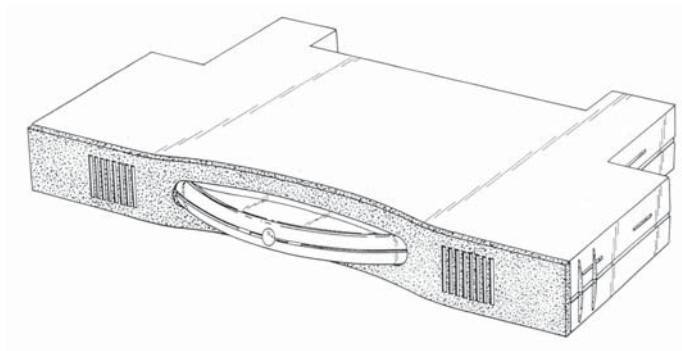

Produkt: Modem, klasse 14-03.
Innehaver: Telefonaktiebolaget LM Ericsson, S-126 25 Stockholm, SE
Fullmektig: Oslo Patentkontor AS, Postboks 7007 Majorstua, 0306 Oslo, NO
Designer: Steve McGugan, Mortonsvej 21, DK-2800 Lyngby, DK
Prioritet: 2002.05.29, SE, nr 02-0857.

Reg.nr: 77586

Søkn.nr: 2003 0089

Inngitt: 2003.02.13

Allm. tilgj.: 2003.02.21

Reg.dat0: 2003.10.09

Kunngjort: 2003.11.10

Reg. gjelder til: 2008.02.13

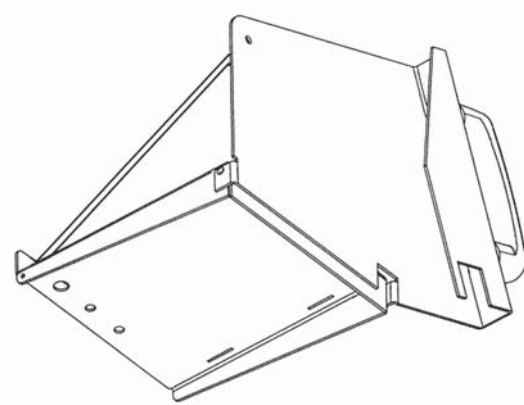
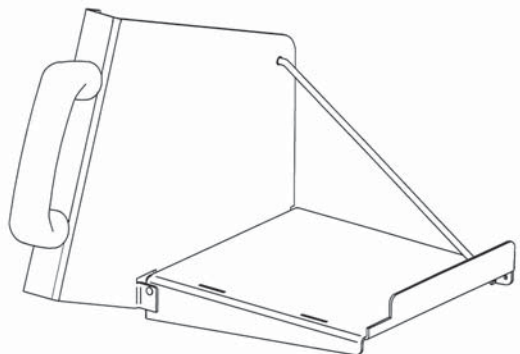

Produkt: Verktøyholder for stige, 25-04.

Innehaver: Hans J. Kotthaus, Nilsabakken 6, Postboks 111, 4339 Ålgård og Halvor Kverneland, Blåberget, 4355 Kvernaland, begge NO

Designer: Hans J. Kotthaus, Nilsabakken 6, Postboks 111, 4339 Ålgård og Halvor Kverneland, Blåberget, 4355 Kvernaland, begge NO

Reg.nr: 77587

Søkn.nr: 2003 0278

Inngitt: 2003.05.09

Allm. tilgj.: 2003.05.14

Reg.dat0: 2003.10.10

Kunngjort: 2003.11.10

Reg. gjelder til: 2008.05.09

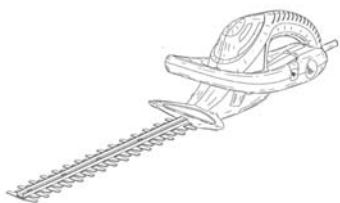

1.1



1.2



1.3



1.4

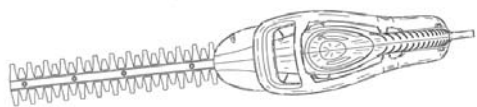

1.5



1.6

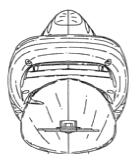

1.7



1.8

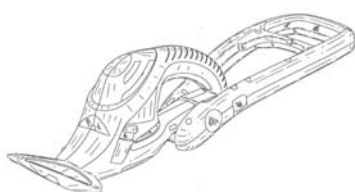

2.1

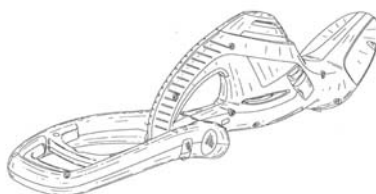

2.2



2.3

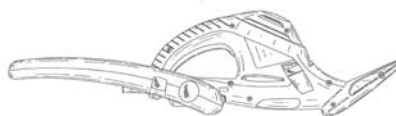

2.4

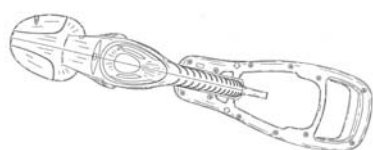

2.5

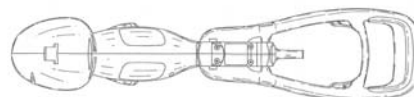

2.6



2.7



2.8

Produkt: 1. Maskin for klipping av vegetasjon, med blad, 2. Maskin for klipping av vegetasjon, uten blad, klasse 8-03.
 Innehaver: Black & Decker Inc., Drummond Plaza Office Park, 1423 Kirkwood Highway, Newark, 19711 Delaware, US
 Fullmektig: Tandbergs Patentkontor AS, Uranienborg terrasse 19, Postboks 7085M, 0306 Oslo, NO
 Designer: Stephen Houghton, 34 Moorfield, High West Jesmond, NE2 3NY, Newcastle upon Tyne, US
 Prioritet: 2002.11.14 US, nr 3008638
 Anmerkning: Det er ikke foretatt supplerende undersøkelse.

Reg.nr: 77588

Søkn.nr: 2003 0354

Allm. tilgj.: 2003.06.20

Kunngjort: 2003.11.10

Inngitt: 2003.06.19

Reg.dat: 2003.10.15

Reg. gjelder til: 2008.06.19

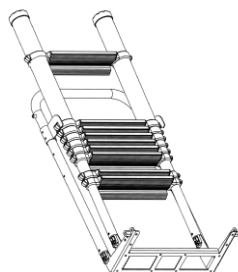

1.1

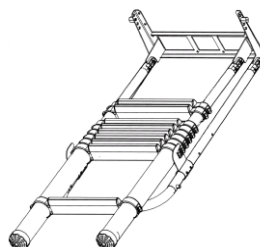

1.2

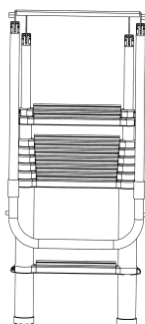

1.3

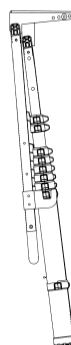

1.4

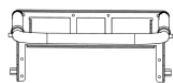

2.1

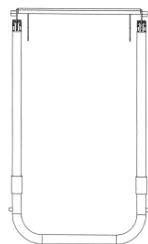

2.2



2.3

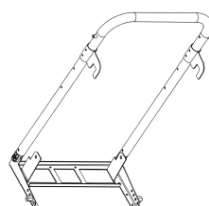

2.4

Produkt: 1. Loftstige, 2. Del til loftstige, klasse 25-04.
 Innehaver: Per-Olof Eriksson, Hättevägen 47, S-573 93 Tranås, SE og Christer Johansson, Romanäsvägen 11, S-573 91 Tranås, SE
 Fullmektig: H. Siebmans, Gotapatent AB, Box 154, S-561 22 Huskvarna, SE
 Designer: Per-Olof Eriksson, Hättevägen 47, S-573 93 Tranås, SE og Christer Johansson, Romanäsvägen 11, S-573 91 Tranås, SE
 Anmerkning: Det er ikke foretatt supplerende undersøkelse.

Reg.nr: 77589

Søkn.nr: 2003 0394

Allm. tilgj.: 2003.10.15

Kunngjort: 2003.11.10

Inngitt: 2003.07.18

Reg.dat: 2003.10.15

Reg. gjelder til: 2008.07.18

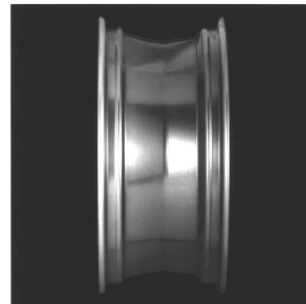

Produkt: Hjulfelg, klasse 12-16.
 Innehaver: Due Emme Mille Miglia S.R.L., Via Cosimo Canovetti 7, IT-25128 Brescia, IT
 Fullmektig: Oslo Patentkontor AS, Postboks 7007 M, 0306 Oslo, NO
 Designer: Fulvio Maifrini, Via Val di Fassa 16, IT-25100 Brescia, IT
 Anmerkning: Det er ikke foretatt supplerende undersøkelse.

Reg.nr: 77590

Søkn.nr: 2002.0108

Inngitt: 2002.02.08

Allm. tilgj.: 2002.08.08

Reg.dato: 2003.10.16

Kunngjort: 2003.11.10

Reg. gjelder til: 2007.02.08

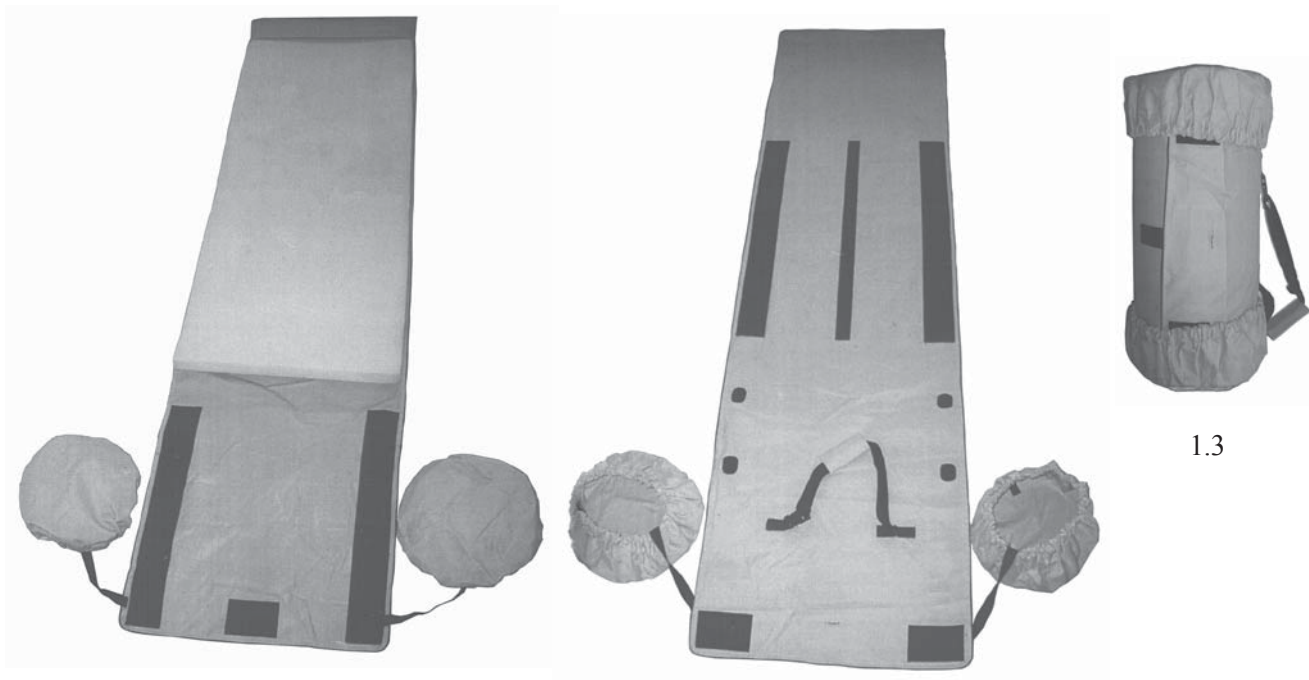

1.1

1.2

1.3

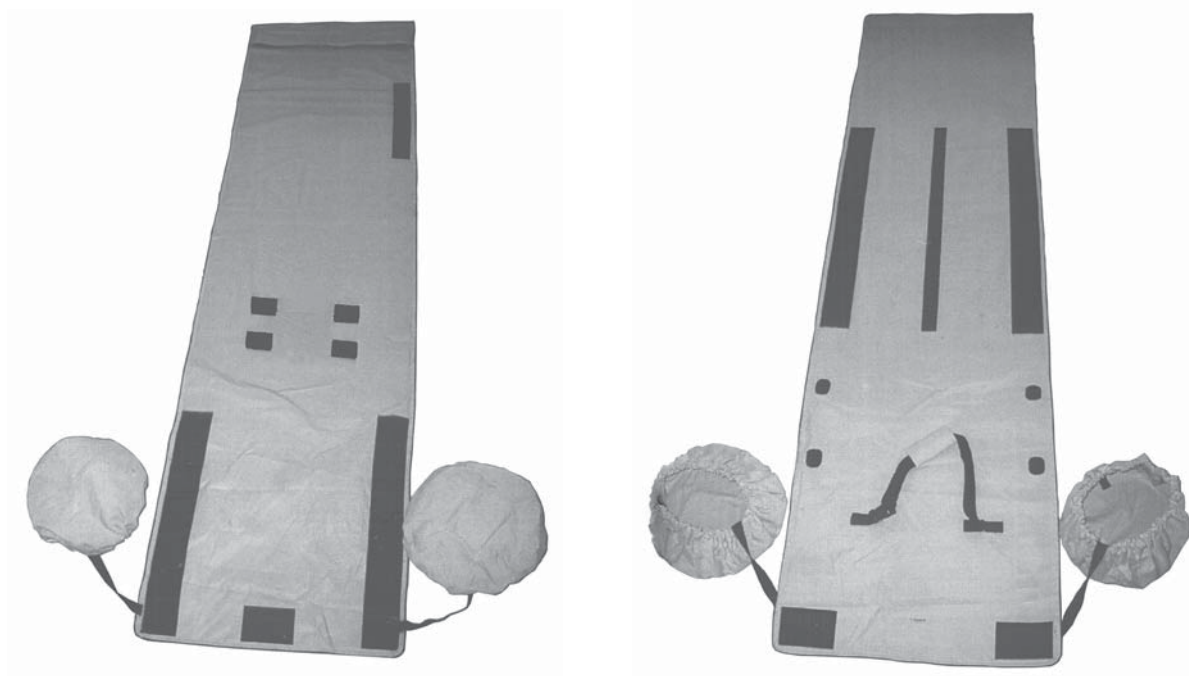

2.1

2.2

Produkt: 1. Liggeunderlag med madrass, 2. Liggeunderlag til samme, klasse 6-09.
Innehaver: Tobias M. Karem, Wilhelms gate 8 B, 0168 Oslo, NO
Designer: Tobias M. Karem, Wilhelms gate 8 B, 0168 Oslo, NO
Anmerkning: Registreringen gjelder samregistrering.

Reg.nr: 77591

Søkn.nr: 2002 0140

Allm. tilgj.: 2002.03.01

Kunngjort: 2003.11.10

Inngitt: 2002.02.26

Reg.dato: 2003.10.16

Reg. gjelder til: 2007.02.26

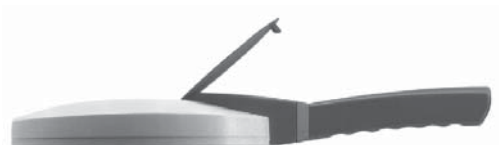
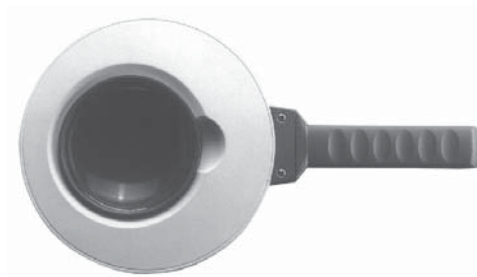

Produkt: Lupelampe, klasse 16-06 og 26-05.
Innehaver: Herbert Waldmann GmbH & Co, Peter-Henlein-Strasse 5, D-78056 Villingen-Schwenningen, DE
Fullmektig: Zacco Norway AS, Postboks 765 Sentrum, 0106 Oslo, NO
Designer: Gerhard Waldmann, Lembergstrasse 7, D-78083 Dauchingen, DE
Prioritet: 2001.09.01, DE, nr 401 07 757.8.
Anmerkning: Registreringen er en variant av reg.nr. 77595.

Reg.nr: 77592

Søkn.nr: 2002 0691

Inngitt: 2002.10.31

Allm. tilgj.: 2003.04.14

Reg.dat: 2003.10.16

Kunngjort: 2003.11.10

Reg. gjelder til: 2007.10.31

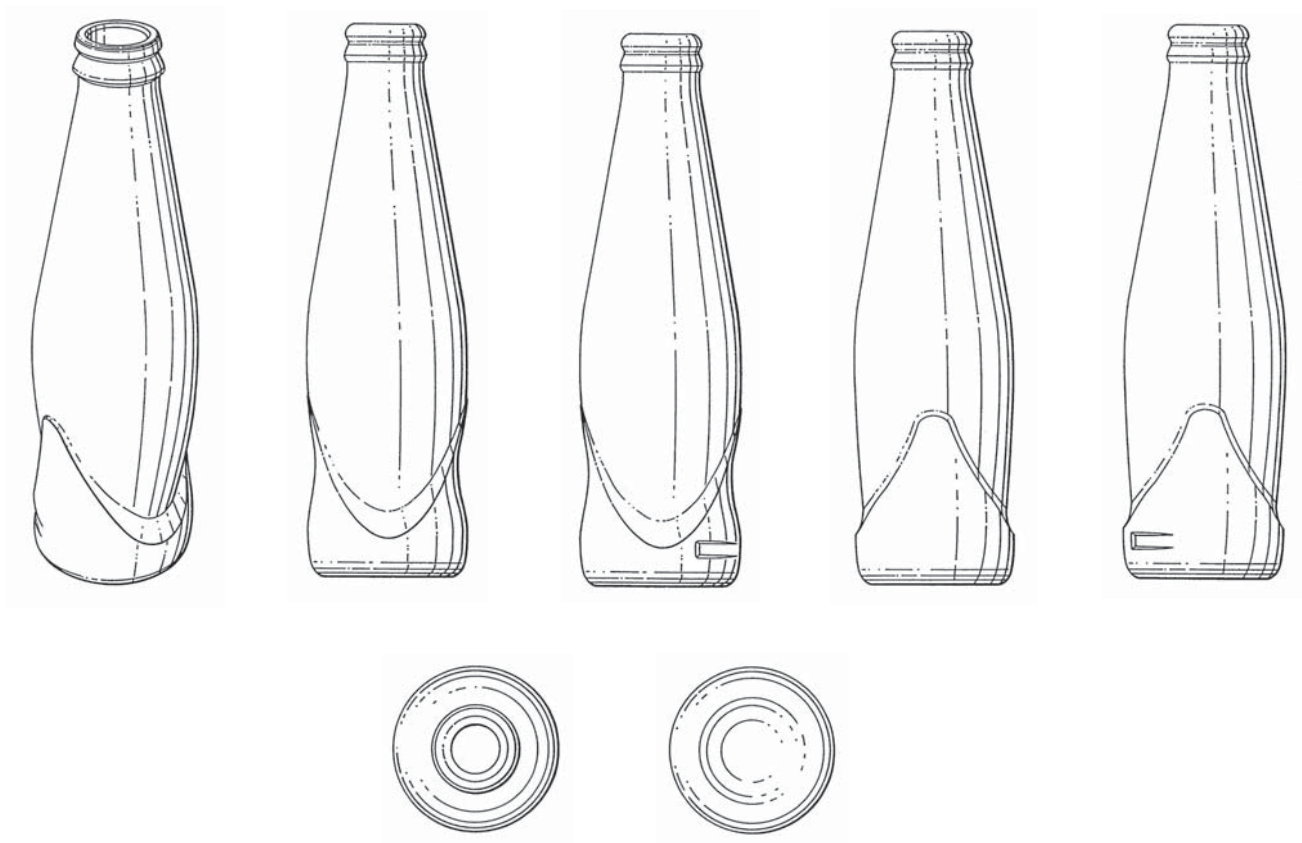

Produkt: Flaske, klasse 9-01.

Innehaver: Schweppes International Ltd, 25 Berkeley Square, London W1X 6HT, England, GB

Fullmektig: Zacco Norway AS, Postboks 765 Sentrum, 0106 Oslo, NO

Designer: David Bicknell, Blue Martin Packaging Design Limited Circus Mews House, Circus Mews, Bath, BA1 2PW, England, GB

Prioritet: 2002.10.14, GB, nr 3.007.749.

Reg.nr: 77593

Søkn.nr: 2002 0692

Inngitt: 2002.10.31

Allm. tilgj.: 2003.04.14

Reg.dato: 2003.10.16

Kunngjort: 2003.11.10

Reg. gjelder til: 2007.10.31

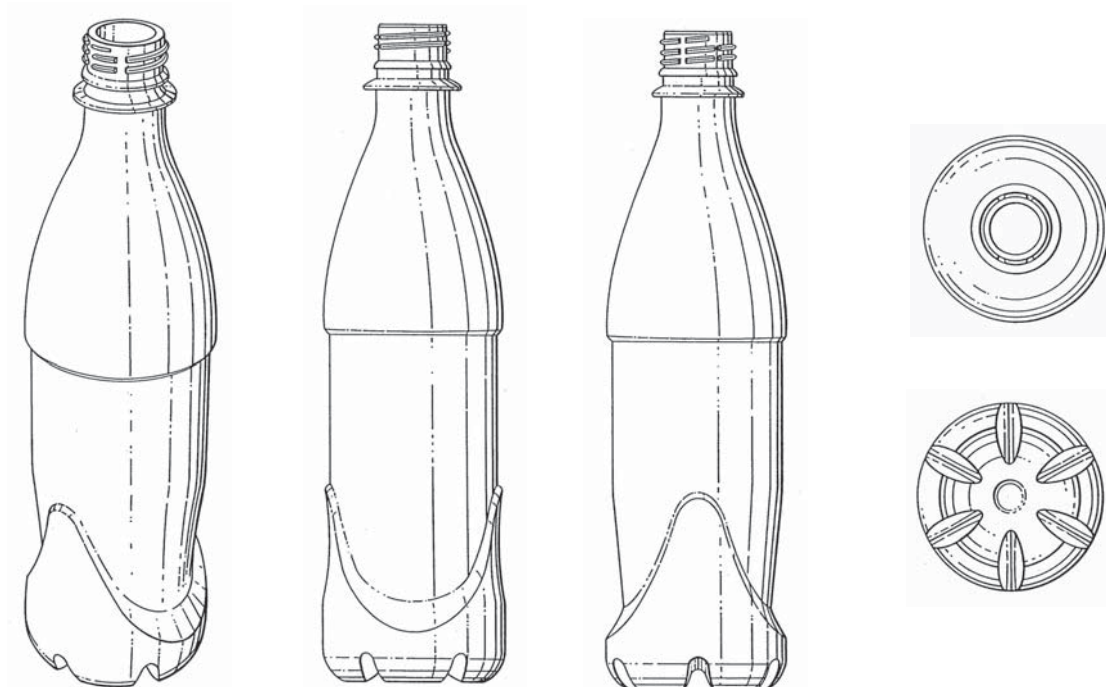

Produkt: Flaske, klasse 9-01.

Innehaver: Schweppes International Ltd, 25 Berkeley Square, London W1X 6HT, England, GB

Fullmektig: Zacco Norway AS, Postboks 765 Sentrum, 0106 Oslo, NO

Designer: David Bicknell, Blue Martin Packaging Design Limited Circus Mews House, Circus Mews, Bath, BA1 2PW, England, GB

Prioritet: 2002.10.14, GB, nr 3.007.748.

Reg.nr: 77594

Søkn.nr: 2002 0738

Inngitt: 2002.11.26

Allm. tilgj.: 2002.11.26

Reg.dato: 2003.10.16

Kunngjort: 2003.11.10

Reg. gjelder til: 2007.11.26

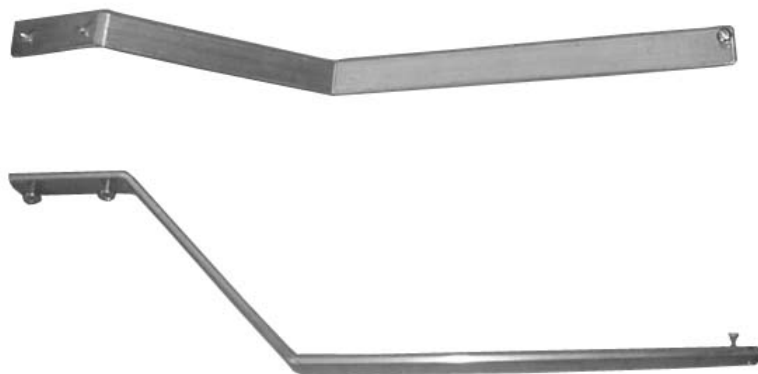

Produkt: Festebrakett for trafo, klasse 8-08.

Innehaver: EL-Produkter AS, 6065 Ulsteinvik, NO

Designer: Hallbjørn Leirvik, 6065 Ulsteinvik, NO

Reg.nr: 77595

Søkn.nr: 2003 0098

Allm. tilgj.: 2002.03.01

Kunngjort: 2003.11.10

Inngitt: 2002.02.26

Reg.dato: 2003.10.16

Reg. gjelder til: 2007.02.26

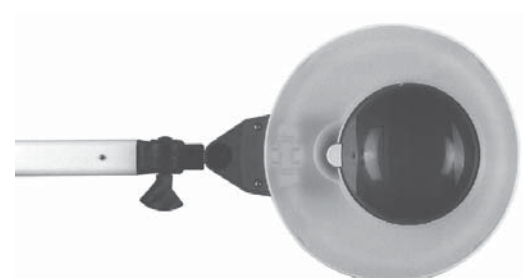
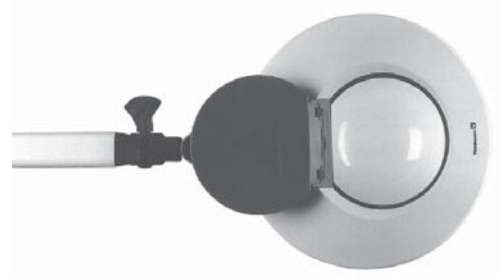
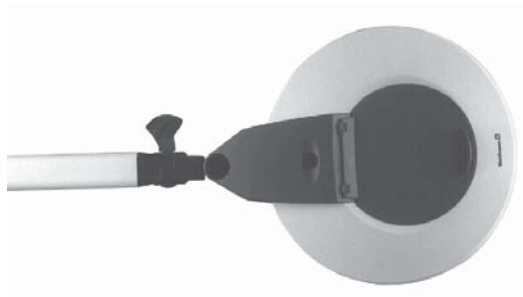

Produkt: Delutseende av lupelampe, klasse 16-06 og 26-05.
Innehaver: Herbert Waldmann GmbH & Co, Peter-Henlein-Strasse 5, D-78056 Villingen-Schwenningen, DE
Fullmektig: Zacco Norway AS, Postboks 765 Sentrum, 0106 Oslo, NO
Designer: Gerhard Waldmann, Lembergstrasse 7, D-78083 Dauchingen, DE
Prioritet: 2001.09.01, DE, nr 401 07 757.8.
Anmerkning: Registreringen er en variant av reg.nr. 77591.

Fornyelse av registreringer

Reg.nr: 67968 Fornyhet til: 2008.10.18
Innehaver: Unilever NV, Burg. s'Jacobplein 1, Rotterdam, NL
Fullmektig: Zacco Norway AS, Postboks 765 Sentrum, 0106 Oslo, NO

Reg.nr: 67974 Fornyhet til: 2008.12.02
Innehaver: Norwesco AS, Postboks 22, 1473 Skårer, NO
Fullmektig: Jens F. C. Langfeldt i Zacco Norway AS, Postboks 765 Sentrum, 0106 Oslo, NO

Reg.nr: 68024 Fornyhet til: 2008.11.08
Innehaver: Novartis AG, Schwarzwaldallee 215, CH-4058 Basel, CH
Fullmektig: Zacco Norway AS, Postboks 765 Sentrum, 0106 Oslo, NO

Reg.nr: 68025 Fornyhet til: 2008.11.08
Innehaver: Novartis AG, Schwarzwaldallee 215, CH-4058 Basel, CH
Fullmektig: Zacco Norway AS, Postboks 765 Sentrum, 0106 Oslo, NO

Reg.nr: 68073 Fornyhet til: 2008.11.02
Innehaver: A/S Ruko, Marienlundvej 20, DK-2730 Herlev, DK
Fullmektig: Eivind Håmsø i Håmsø Patentbyrå ANS, Postboks 171, 4302 Sandnes, NO

Reg.nr: 68118 Fornyhet til: 2008.11.02
Innehaver: A/S Ruko, Marienlundvej 20, DK-2730 Herlev, DK
Fullmektig: Eivind Håmsø i Håmsø Patentbyrå ANS, Postboks 171, 4302 Sandnes, NO

Reg.nr: 68677 Fornyhet til: 2008.10.17
Innehaver: Alfa-Laval Agri Scandinavia AB, Box 617, S-151 27 Södertälje, SE
Fullmektig: Ole J. Aarflot i Bryn Aarflot AS, Postboks 449 Sentrum, 0104 Oslo, NO

Reg.nr: 72475 Fornyhet til: 2009.01.24
Innehaver: Norden Pac Development AB, Box 845, S-391 28 Kalmar, SE
Fullmektig: ABC-Patent, Siviling. Rolf Chr. B. Larsen AS, Postboks 6150 Etterstad, 0602 Oslo, NO

Reg.nr: 74661 Fornyhet til: 2008.10.05
Innehaver: PLM AB, Djäknegatan 16, S-201 80 Malmö, SE
Fullmektig: Awapatent AB, Box 5117, S-200 71 Malmö, SE

Reg.nr: 74710 Fornyhet til: 2008.10.19
Innehaver: Black & Decker Inc, Drummond Plaza Office Park, 1423 Kirkwood Highway, Newark, DE 19711, US
Fullmektig: Tandbergs Patentkontor AS, Postboks 7085 Majorstua, 0306 Oslo, NO

- Reg.nr: 74973 Fornyhet til: 2008.10.07
Innehaver: Dalmatic A/S, Møgelsgaardsvej 47, DK-8520 Lystrup, DK
Fullmektig: Bryn Aarflot AS, Postboks 449 Sentrum, 0104 Oslo, NO
- Reg.nr: 75195 Fornyhet til: 2008.10.28
Innehaver: Mul-T-Lock Technologies Ltd, Mul-T-Lock Park, Yavne 81104, IL
Fullmektig: Jens F.C. Langfeldt i Zacco Norway AS, Postboks 765 Sentrum, 0106 Oslo, NO
- Reg.nr: 75196 Fornyhet til: 2008.10.28
Innehaver: Mul-T-Lock Technologies Ltd, Mul-T-Lock Park, Yavne 81104, IL
Fullmektig: Jens F.C. Langfeldt i Zacco Norway AS, Postboks 765 Sentrum, 0106 Oslo, NO
- Reg.nr: 75199 Fornyhet til: 2008.12.02
Innehaver: Duri Svenska AB, Kryptongatan 1, S-431 53 Mölndal, SE
Fullmektig: Actio-Lassen AS, Postboks 1880 Nordnes, 5817 Bergen, NO
- Reg.nr: 75313 Fornyhet til: 2008.10.28
Innehaver: Mul-T-Lock Technologies Ltd, Mul-T-Lock Park, Yavne 81104, IL
Fullmektig: Zacco Norway AS, Postboks 765 Sentrum, 0106 Oslo, NO
- Reg.nr: 75725 Fornyhet til: 2009.10.04
Innehaver: Buttress BV, Vleutensevaart 100, NL-3532 AD Utrecht, NL
Fullmektig: AS Bergen Patentkontor, Postboks 1998 Nordnes, 5817 Bergen, NO
- Reg.nr: 76022 Fornyhet til: 2009.06.28
Innehaver: Sara Lee Household and Body Care Nederland BV, Traverse 2, NL-3905 NL Veenendaal, NL
Fullmektig: Zacco Norway AS, Postboks 765 Sentrum, 0106 Oslo, NO