



Norsk

# design tidende

[www.patentstyret.no](http://www.patentstyret.no)

Norsk designtidende er en publikasjon som inneholder kunngjøringer innenfor designområdet

**BESØKSADRESSE**

- ▶ Københavngaten 10

**POSTADRESSE**

- ▶ Postboks 8160 Dep.  
0033 Oslo

**E-POST**

- ▶ [mail@patentstyret.no](mailto:mail@patentstyret.no)

**TELEFON**

- ▶ 22 38 73 00

**TELEFAKS**

- ▶ 22 38 73 01

**INFOSENTERETS TELEFONID**

- ▶ kl. 09.00 - 15.00  
Telefon (+47) 22 38 73 33  
Telefax (+47) 22 38 73 31

## Innholdsfortegnelse

### **Designsaker**

|                                   |      |    |
|-----------------------------------|------|----|
| Registrerte mønstre .....         | side | 3  |
| Fornyelse av registreringer ..... | »    | 12 |

## REGISTRERTE DESIGN

*I henhold til designloven § 18 første ledd i.f. kunngjøres i dag følgende registrerte design.*

Det kan fremsettes krav om at designregistreringen helt eller delvis skal oppheves, jf designloven §§ 25 flg. og designforskriften §§ 26 flg.

Designregistreringen gjelder for den eller de periodene på fem år som søknaden er innlevert for, regnet fra søknadsdagen. Registreringen kan fornyes, jf designloven §§ 23 og 24. Maksimal beskyttelsestid er 25 år. For reservedeler, se unntaket i designloven § 23 annet ledd.

**Reg.nr: 77526**

Søkn.nr: 2001 0341

Inngitt: 2001.06.08

Allm. tilgj.: 2001.12.08

Reg.dato: 2003.07.31

Kunngjort: 2003.09.01

Reg. gjelder til: 2006.06.08



Produkt: Fotball, klasse 21-02.

Innehaver: Lenna K. Asphjell, Gjesdalsgt. 14, 4015 Stavanger, NO

Designer: Innehaveren.

**Reg.nr: 77527**

Søkn.nr: 2001 0508

Inngitt: 2001.08.29

Allm. tilgj.: 2001.09.02

Reg.dato: 2003.07.31

Kunngjort: 2003.09.01

Reg. gjelder til: 2006.08.29

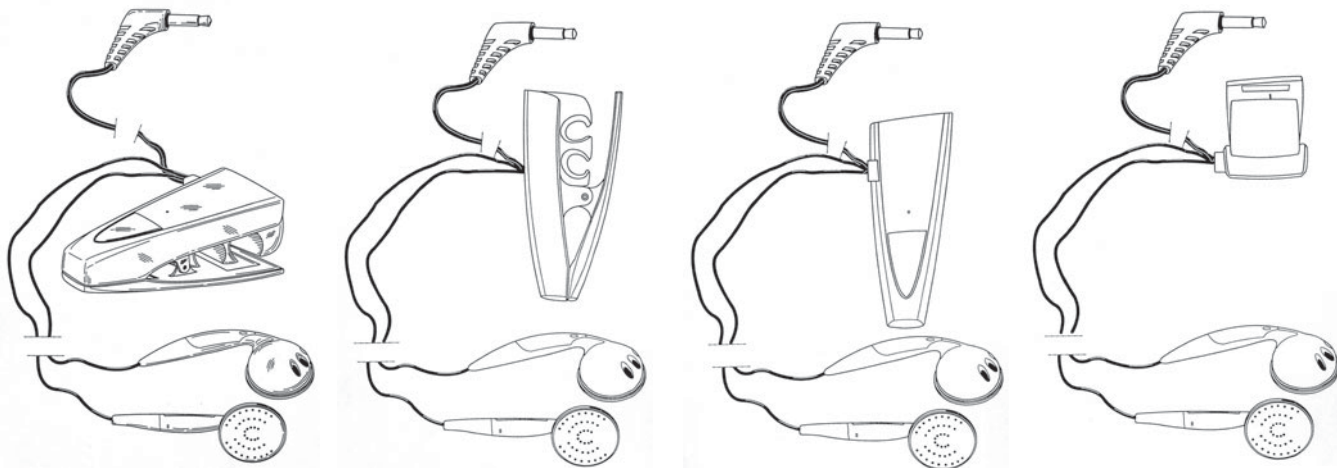

Produkt: Hodesett, klasse 14-01 og 14-03.  
 Innehaver: Nokia Corp, Keilalahdentie 4, SF-02150 Esbo, FI  
 Fullmektig: AS Bergen Patentkontor, Postboks 1998 Nordnes, 5817 Bergen, NO  
 Designer: Matti Juhani (Jussi) Ruohonen, Piispankatu 6 D 40-41,  
 SF-20500 Turku, FI  
 Prioritet: 2001.03.02, FI, nr. M20010145.

**Reg.nr: 77528**

Søkn.nr: 2002 0447

Inngitt: 2002.07.09

Allm. tilgj.: 2002.08.15

Reg.dato: 2003.07.31

Kunngjort: 2003.09.01

Reg. gjelder til: 2007.07.09

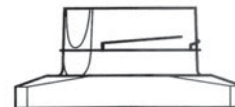
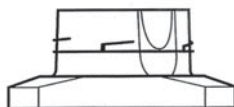
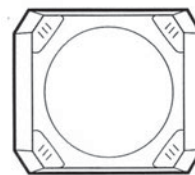
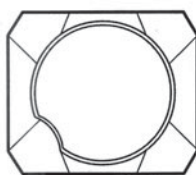
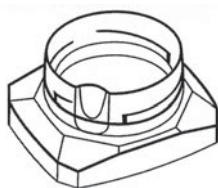

Produkt: Beholder, klasse 09-01.  
 Innehaver: Société des Produits Nestlé SA, Case postale 353, CH-1800 Vevey, CH  
 Fullmektig: Zacco Norway AS, Postboks 765 Sentrum, 0106 Oslo, NO  
 Designer: Jean Servaux, Avenue de Sully 92, CH-1814 La Tour-de-Peilz, CH  
 Prioritet: 2002.02.15, WO, nr. DM/059654.

**Reg.nr: 77529**

Søkn.nr: 2002 0516

Inngitt: 2002.08.21

Allm. tilgj.: 2002.08.23

Reg.dato: 2003.07.31

Kunngjort: 2003.09.01

Reg. gjelder til: 2007.08.21

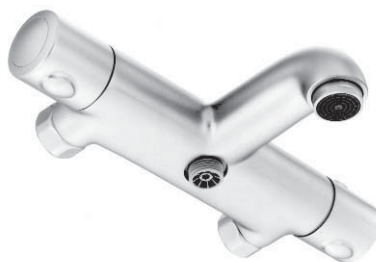

Produkt: Blandebatteri, klasse 23-01.  
 Innehaver: Hansgrohe AG, Auestrasse 5-9, 77761 Schiltach, DE  
 Fullmektig: Zacco Norway AS, Postboks 765 Sentrum, 0106 Oslo, NO  
 Designer: Felix Heck, Werastrasse 8, D-70182 Stuttgart, Tom Schönherr, Argonnenstrasse 22, D-70374 Stuttgart, Andreas Haug, Franklinstrasse 77, D-70435 Stuttgart, alle DE  
 Prioritet: 2002.02.23, DE, nr. 402 01 581.9.

**Reg.nr: 77530**

Søkn.nr: 2002 0562

Inngitt: 2002.09.05

Allm. tilgj.: 2002.09.05

Reg.dato: 2003.07.31

Kunngjort: 2003.09.01

Reg. gjelder til: 2007.09.05

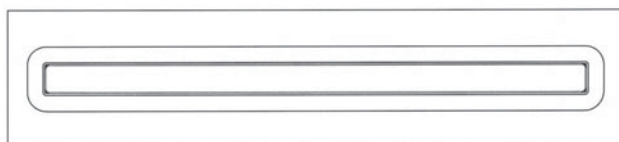
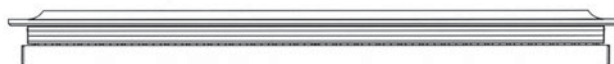
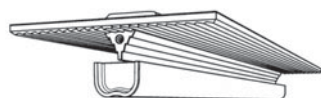

Produkt: Lampe, klasse 26-05.  
 Innehaver: Koninklijke Philips Electronics NV, Groenewoudseweg 1, NL-5621 BA Eindhoven, NL  
 Fullmektig: Zacco Norway AS, Postboks 765 Sentrum, 0106 Oslo, NO  
 Designer: Ramon Janssen, 1e Wilakkersstraat 46, NL-5614 BH Eindhoven, Petrus Adrianus Josephus Holten, Wehmerstraat 2, NL-7121 DP Aalten, begge NL  
 Prioritet: 2002.03.06, WO, nr. DMA/005636.

**Reg.nr: 77531**

Søkn.nr: 2003 0306

Inngitt: 2003.05.23

Allm. tilgj.: 2003.05.23

Reg.dat: 2003.08.06

Kunngjort: 2003.09.01

Reg. gjelder til: 2008.05.23

Produkt: I. Grillpinne, II. Grillpinne, klasse 7-02.  
Innehaver: Vigdis L. Johansen, Røykås terrasse 64,  
1476 Rasta, NO  
Fullmektig: Onsagers AS, Postboks 6963 St Olavs Plass,  
0130 Oslo, NO  
Designer: Innehaveren.

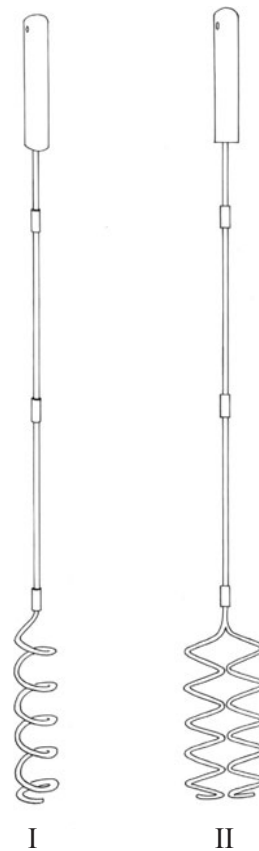

**Reg.nr: 77532**

Søkn.nr: 2002 0314

Allm. tilgj.: 2003.08.12

Kunngjort: 2003.09.01

Inngitt: 2003.05.28

Reg.dat: 2003.08.25

Reg. gjelder til: 2008.05.28

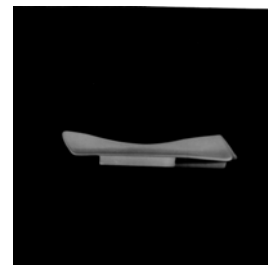
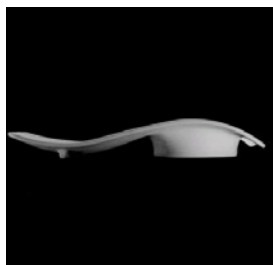
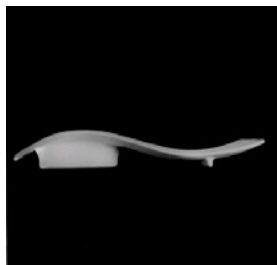
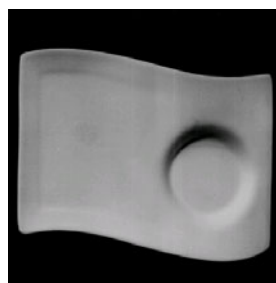
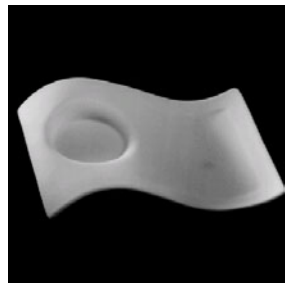

Produkt: Fat, klasse 7-01.  
Innehaver: Villeroy & Boch AG, Saaruferstrasse 14-18, D-66693 Mettlach, DE  
Fullmektig: Curo AS, Postboks 38, 7231 Lundamo, NO  
Designer: Helmut Frank, Hubertusstrasse 19, D-66693 Mettlach-Weiten, DE  
Prioritet: 2003.02.12, WO, nr. DM/062896  
Anmerkning: Det er ikke foretatt supplerende undersøkelse.

**Reg.nr: 77533**

Søkn.nr: 2002 0015

Allm. tilgj.: 2002.01.09

Kunngjort: 2003.09.01

Inngitt: 2002.01.08

Reg.dato: 2003.08.07

Reg. gjelder til: 2007.01.08

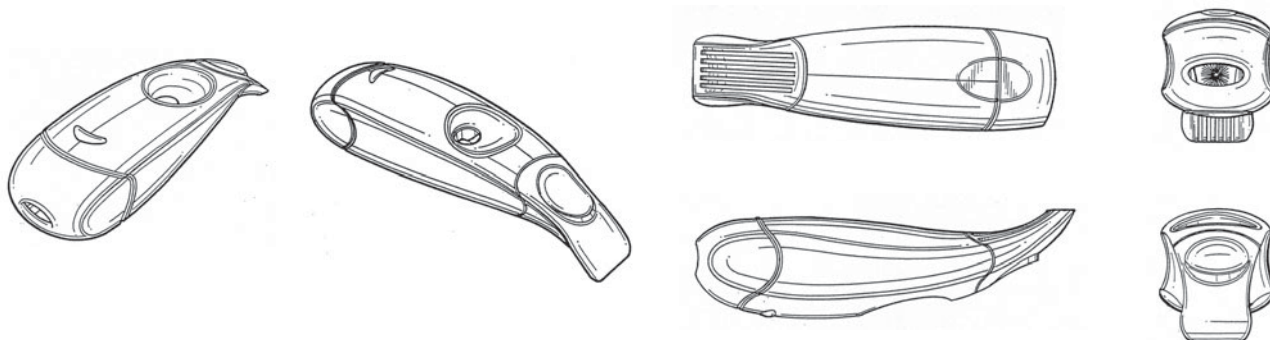

Produkt: Renseinnretning for lighter, klasse 27-99.

Innehaver: Philip Morris Products Inc, 3601 Commerce Road, Richmond VA 23234, US

Fullmektig: Onsagers AS, Postboks 6963 St Olavs Plass, 0130 Oslo, NO

Designer: John M Campbell, 9606 Waterfall Cove Dr, Chesterfield, VA 23832, Wendy Marin Weiner, 56 Woodlawn Avenue, New Rochelle, NY 10804, Robert Pandorf, 61 Hawthorne Terrace, Ieonia, NJ 07605, William James Crowe, 11120 Chalkley Road, Chesterfield, VA 23831, Brett W Stevenson, 1848 Glencove Lane, Richmond, VA 23225, Grier Fleischhauer, 1004 Lady Jean Court, Midlothian, VA 23113, alle US og Christopher O'Brien Wheeler, 109-1045 West 14th Avenue, Vancouver BC V6H 1P4, CA

Prioritet: 2001.07.09, US, nr. 29/144.600.



**Reg.nr: 77534**

Søkn.nr: 2002 0019

Inngitt: 2002.01.11

Allm. tilgj.: 2002.01.11

Reg.dat0: 2003.08.07

Kunngjort: 2003.09.01

Reg. gjelder til: 2007.01.11

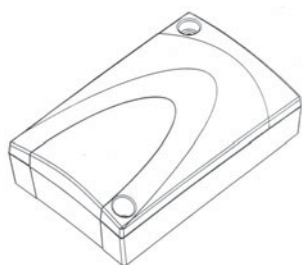

I

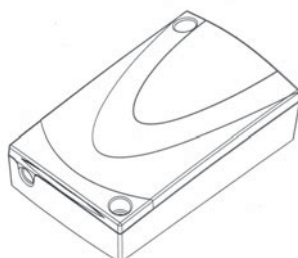

I



I

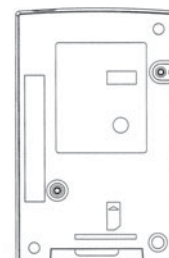

I

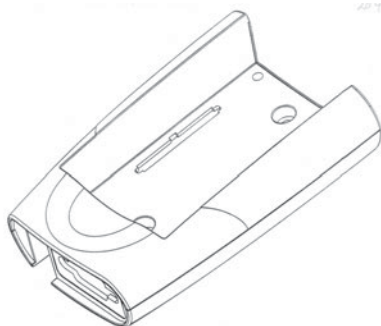

II

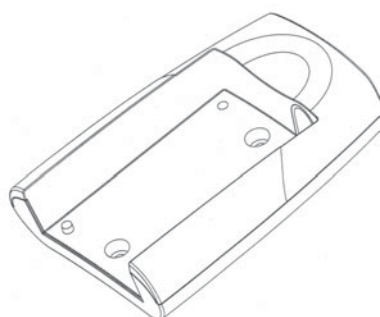

II



II

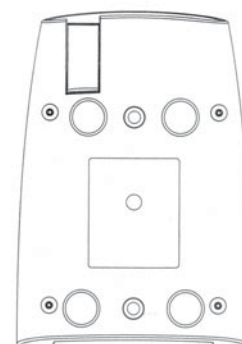

II

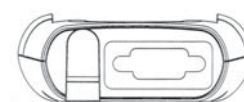

II

Produkt: I. GSM tilkoblingsterminal , II. Dataadapter til samme, klasse 14-03.  
Innehaver: Nokia Corp, Keilalahdentie 4, SF-02150 Esbo, FI  
Fullmektig: AS Bergen Patentkontor, Postboks 1998 Nordnes, 5817 Bergen, NO  
Designer: Petri Tuhkanen, Hanhitie 17 J B 13, SF-90150 Oulu, FI  
Prioritet: 2001.10.10, FI, nr. M20010683.  
Anmerkning: Registreringen gjelder samregistrering.

**Reg.nr: 77535**

Søkn.nr: 2002 0175

Allm. tilgj.: 2002.09.11

Kunngjort: 2003.09.01

Inngitt: 2002.03.11

Reg.dat: 2003.08.07

Reg. gjelder til: 2007.03.11

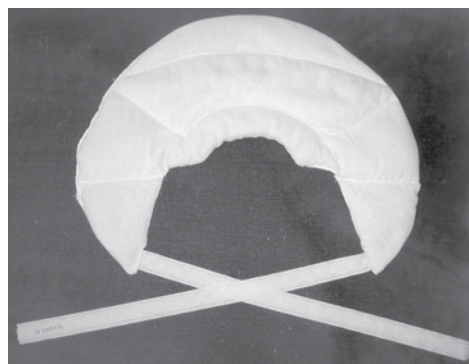
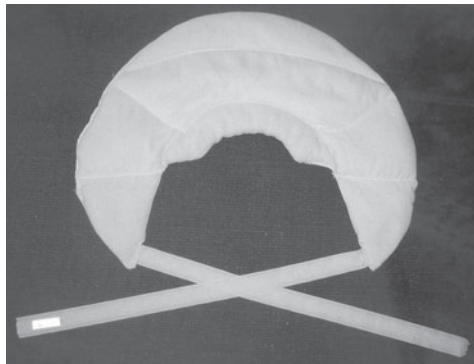

Produkt: Pute for varmebehandling av kroppsdeler, klasse 24-04.  
 Innehaver: Torill Lisbet Fjørtoft, 6294 Fjørtoft, NO  
 Fullmektig: Curo AS, Postboks 38, 7231 Lundamo, NO  
 Designer: Innehaveren.

**Reg.nr: 77536**

Søkn.nr: 2002 0300

Allm. tilgj.: 2002.05.06

Kunngjort: 2003.09.01

Inngitt: 2002.05.06

Reg.dat: 2003.08.07

Reg. gjelder til: 2007.05.06

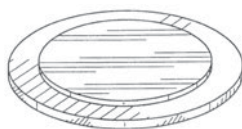

I



I

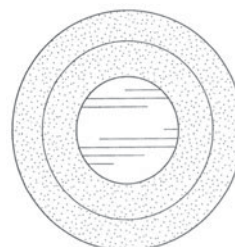

I

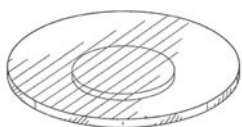

II



II

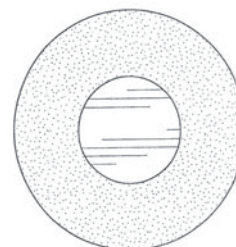

II

Produkt: I. Plaster med laminat, II. Plaster til samme, klasse 24-04.  
 Innehaver: Boehringer Ingelheim Pharmaceuticals Inc, 900 Ridgebury Road, Ridgefield, CT 06877, US  
 Fullmektig: Tandbergs Patentkontor AS, Postboks 7085 Majorstua, 0306 Oslo, NO  
 Designer: Stephen Horhota, 13 Prospect Drive, Brookfield, CT 06804, Said Sam, 5 Nature View Lane, New Milford, CT 06776, Leigh Ann Rondano, 75 Plumtrees Road, Bethel, CT 06801 og Michael Hardy, 177 Russian Village Road, Southbury, CT 06488, alle US  
 Prioritet: 2001.11.06, US, nr. 29/150.538 for løpenr. I og US, nr. 29/150.550 for løpenr. II.  
 Anmerkning: Registreringen gjelder samregistrering.

**Reg.nr: 77537**

Søkn.nr: 2002 0663

Allm. tilgj.: 2002.10.25

Kunngjort: 2003.09.01

Inngitt: 2002.10.17

Reg.dat: 2003.08.07

Reg. gjelder til: 2007.10.17

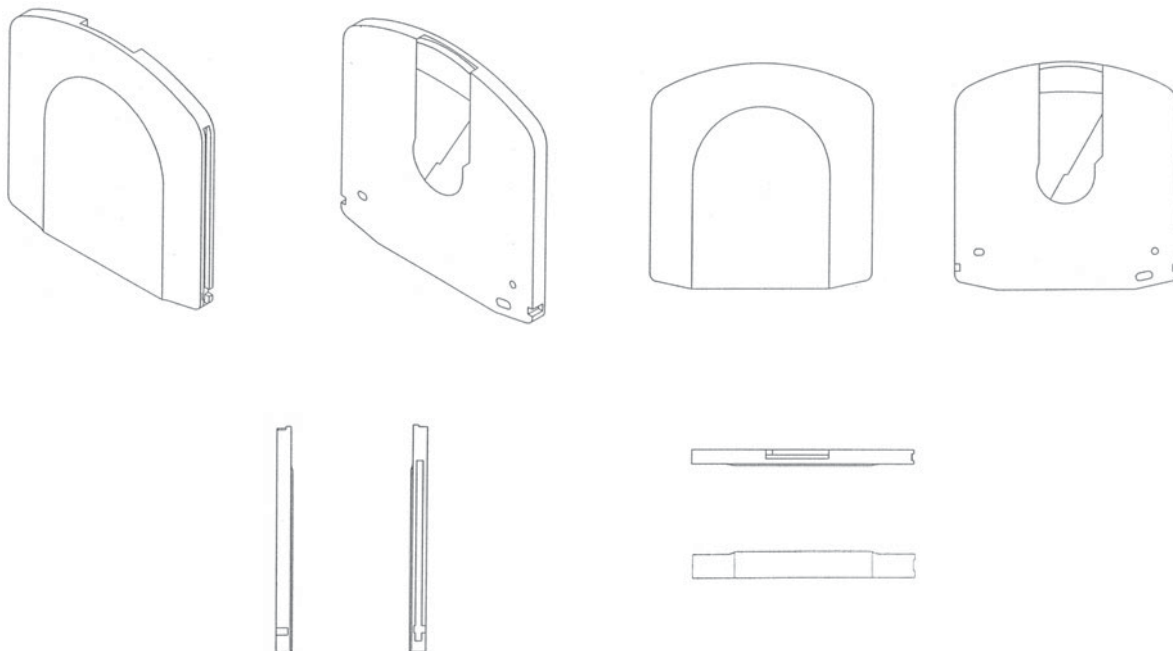

Produkt: Kasset for optisk plate, klasse 14-99.

Innehaver: Sony Kabushiki Kaisha (also trading as Sony Corporation), 7-35 Kitashinagawa 6-chome, Shinagawa-ku, Tokyo, JP

Fullmektig: J.K. Thorsens Patentbureau AS, Postboks 9276 Grønland, 0134 Oslo, NO

Designer: Takuya Nitsu, c/o Sony Corporation, 7-35 Kitashinagawa 6-chome, Shinagawa-ku, Tokyo, JP

Prioritet: 2002.04.25, JP, nr. 2002-011231.



