



Norsk

design tidende

www.patentstyret.no

Norsk designtidende er en publikasjon som inneholder kunngjøringer innenfor designområdet

BESØKSADRESSE

- ▶ Københavngaten 10

POSTADRESSE

- ▶ Postboks 8160 Dep.
0033 Oslo

E-POST

- ▶ mail@patentstyret.no

TELEFON

- ▶ 22 38 73 00

TELEFAKS

- ▶ 22 38 73 01

INFOSENTERETS TELEFON Tid

- ▶ kl. 09.00 - 15.00
Telefon (+47) 22 38 73 33
Telefax (+47) 22 38 73 31

Innholdsfortegnelse

Designsaker

Registrert design	side	3
Fornyelse av registreringer	»	20
Rettelser	»	23

Mønstersaker

Avgjørelser i innsigelser	»	24
---------------------------------	---	----

REGISTRERT DESIGN

I henhold til designloven § 18 første ledd i.f. kunngjøres i dag følgende registrerte design.

Det kan fremsettes krav om at designregistreringen helt eller delvis skal oppheves, jf designloven §§ 25 flg. og designforskriften §§ 26 flg.

Designregistreringen gjelder for den eller de periodene på fem år som søknaden er innlevert for, regnet fra søknadsdagen. Registreringen kan fornyes, jf designloven §§ 23 og 24. Maksimal beskyttelsestid er 25 år. For reservedeler, se unntaket i designloven § 23 annet ledd.

Reg.nr: 77699

Søkn.nr: 2003 0399

Allm. tilgj.: 2003.08.21

Kunngjort: 2004.02.16

Inngitt: 2003.07.21

Reg.dato: 2004.01.21

Reg. gjelder til: 2008.07.21

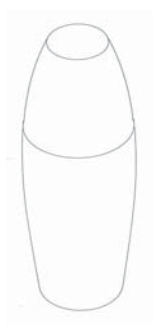

1.1

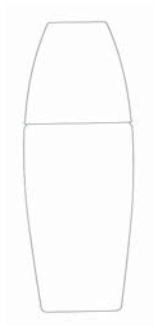

1.2



Tverrsnitt



2.1



2.2



3.1



3.2

Produkter : 1. Karaffel med kopp, 2, Karaffel uten kopp, 3. Kopp til karaffel, klasse 7-01.

Innehaver : PI-Design AG, Kantonsstrasse 100, CH-6234 Triengen, CH

Fullmektig: Actio-Lassen AS, Postboks 1880 Nordnes, 5817 Bergen, NO

Designer : Jørgen Bodum, St Niklausenstrasse 23, CH-6005 St. Niklausen, CH

Prioritet: 2003.02.21, DK, nr. 2003 00139.

Anmerkning: Registreringen gjelder samregistrering.
Det er ikke foretatt supplerende undersøkelse.

Reg.nr: 77700

Søkn.nr: 2000 0632

Inngitt: 2000.09.19

Allm. tilgj.: 2000.09.23

Reg.dat0: 2004.01.22

Kunngjort: 2004.02.16

Reg. gjelder til: 2005.09.19

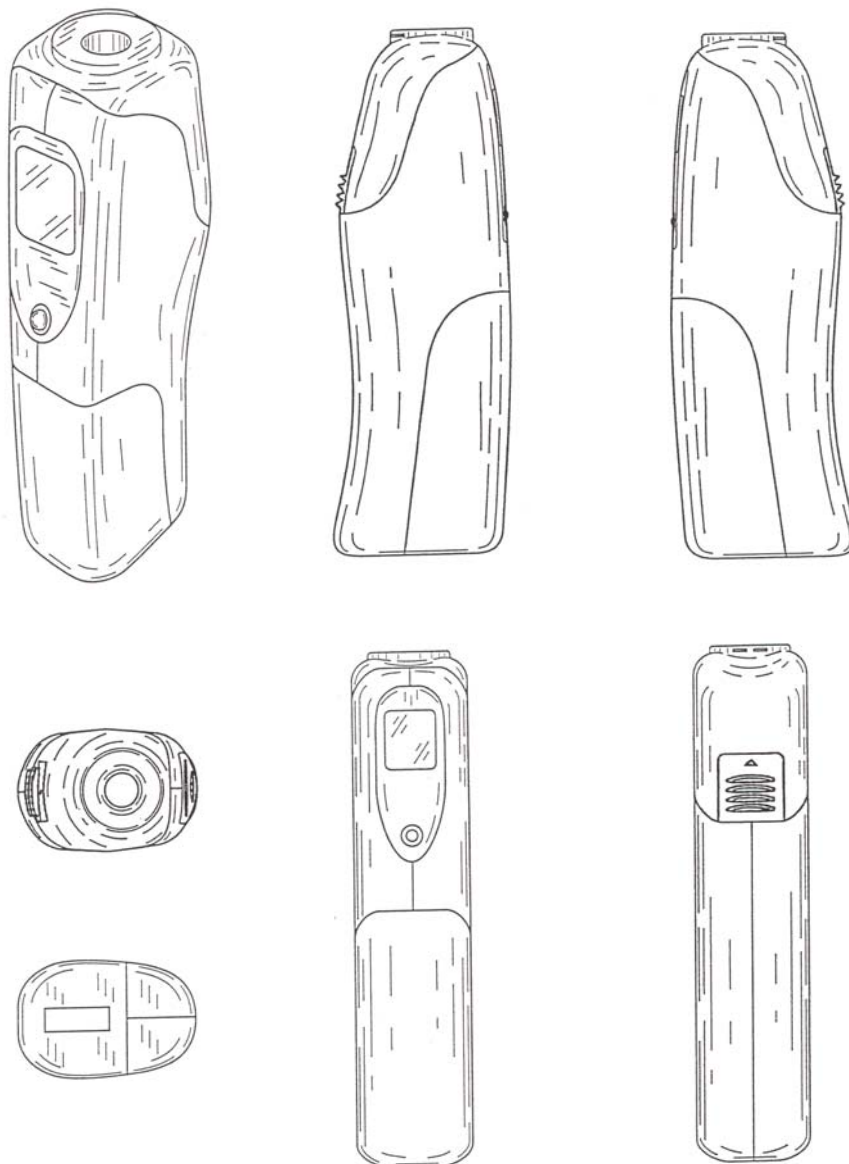

Produkt:

Lighter, klasse 27-05.

Innehaver:

Philip Morris Products Inc, 3601 Commerce Road, Richmond, VA 23234, US

Fullmektig:

Onsagers AS, Postboks 6963 St Olavs Plass, 0130 Oslo, NO

Designer:

Arun Sinha, 143 Emery Drive East, Stamford CT 06902, US, Wendy Marin, 56 Woodlawn Avenue, New Rochelle, NY 10804, US, Brendan Anderson, 200 East 89th St, Apt 17 A, New York, NY 10128, US, Jan Jones, 14328 Regatta Pte Rd, Midlothian, VA 23112, US, Robert Pandorf, 231 Pascack Avenue, Emerson, NJ 07630, US, James Collins, 449 West 44th Street, Apt 2 E, New York, NY 10036, US, Charles T. Higgins, 30 Glenbrooke Circle West, Richmond, VA 23229, US, William James Crowe, 11120 Chalkley Road, Chester, VA 23831, US, Takahide Takeda, 2325-13 Shizuki, Tsuna-Cho, Tsuna-Gun, Hyogo 656-3231, JP, Chuck Krausie, 69 Noe Street, San Francisco, CA 94114, US og Phil Hill, 34 Ashley Place, Martinez, CA 94553, US

Prioritet:

2000.03.23, US, 29/120626.

Reg.nr: 77701

Søkn.nr: 2002 0170

Inngitt: 2002.03.07

Allm. tilgj.: 2002.03.07

Reg.dato: 2004.01.22

Kunngjort: 2004.02.16

Reg. gjelder til: 2007.03.07

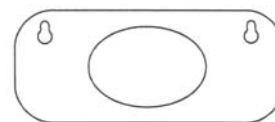
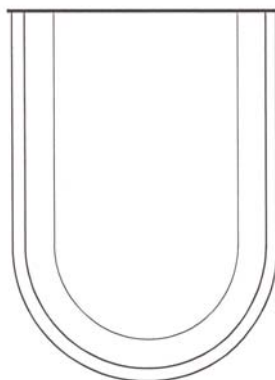
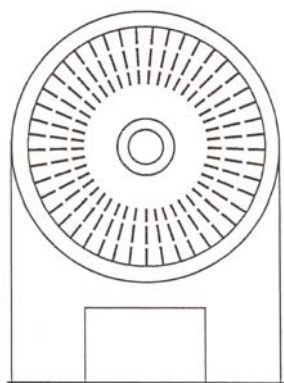

Produkt: Damphette, klasse 23-04.
Innehaver: Trepol A/S, Ursusvej 5, Skovby, DK-8464 Galten, DK
Fullmektig: Bryn Aarflot AS, Postboks 449 Sentrum, 0104 Oslo, NO
Designer: Richard Poulsen, G1 Stillingvej 425, DK-8464 Harlev Jylland, DK
Prioritet: 2001.09.07, DK, MA 2001 00904.

Reg.nr: 77702

Søkn.nr: 2002 0391

Inngitt: 2002.06.14

Allm. tilgj.: 2002.06.17

Reg.dat0: 2004.01.22

Kunngjort: 2004.02.16

Reg. gjelder til: 2007.06.14



Produkt: Belysningsanordning for ute- og innebruk, klasse 26-03 og 26-05.
Innehaver: iGuzzini Illuminazione Srl, SS-77, Km 102, I-62019 Recanati, Macerata, IT
Fullmektig: Zacco Norway AS, Postboks 765 Sentrum, 0106 Oslo, NO
Designer: Adolfo Guzzini, C da Duomo, 33/A, Recanati, Macerata, IT
Prioritet: 2001.12.17, IT, MI2001 O 000827.

Reg.nr: 77703

Søkn.nr: 2003 0161

Allm. tilgj.: 2003.03.20

Kunngjort: 2004.02.16

Inngitt: 2003.03.12

Reg.dato: 2004.01.22

Reg. gjelder til: 2008.03.12

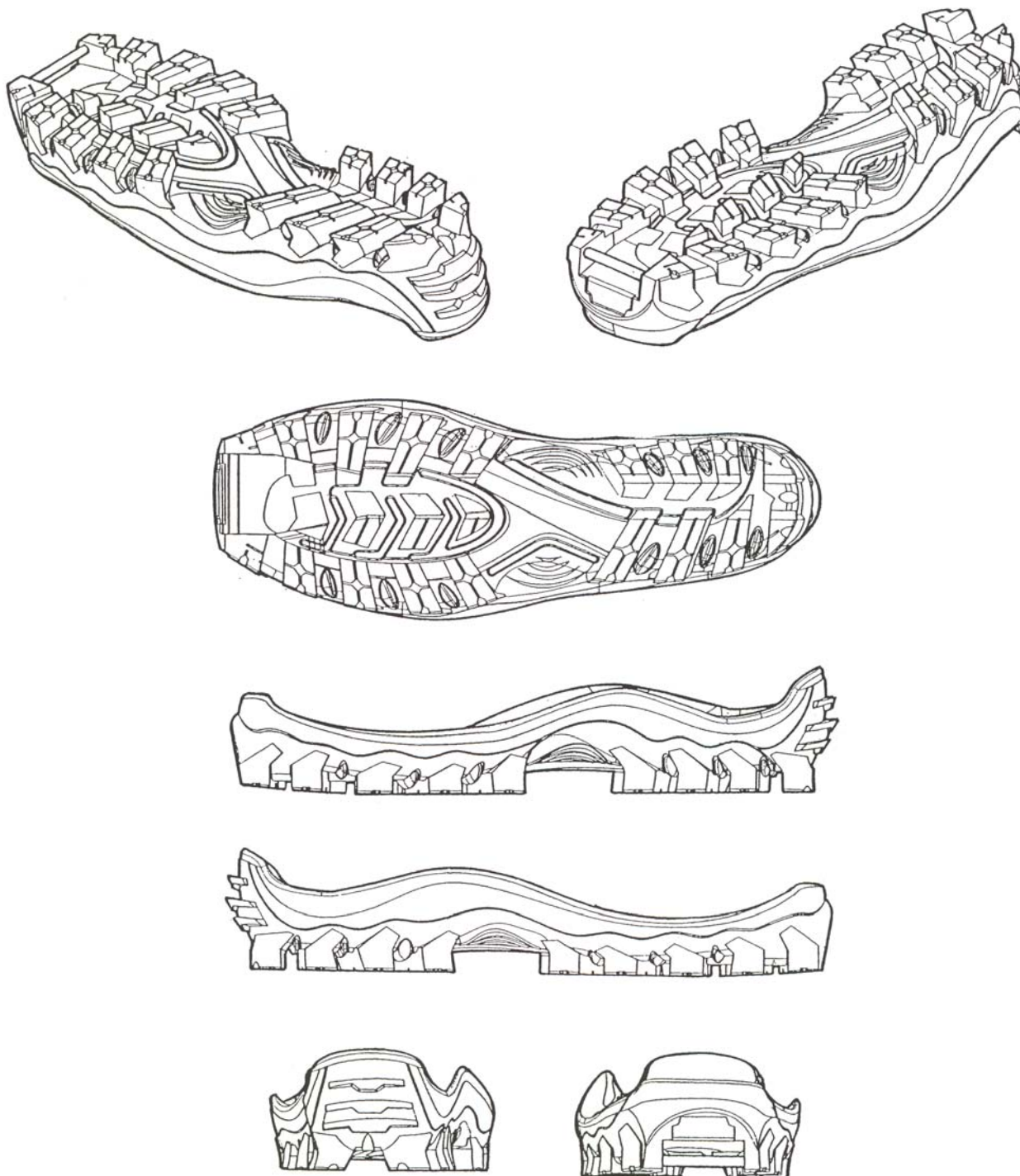

Produkt: Skosåle, klasse 2-04.
Innehaver: Salomon SA, Lieudit la Ravoire, F- 74370 Metz-Tessy, FR
Fullmektig: Oslo Patentkontor AS, Postboks 7007 Majorstua, 0306 Oslo, NO
Designer: Bruno Lancon, Routes des Charres, F-74350 Villy le Pelloux, FR
Prioritet: 2002.09.20, WO, DM/061 763.

Reg.nr: 77704

Søkn.nr: 2003 0550

Inngitt: 2002.11.13

Allm. tilgj.: 2002.11.13

Reg.dato: 2004.01.23

Kunngjort: 2004.02.16

Reg. gjelder til: 2007.11.13

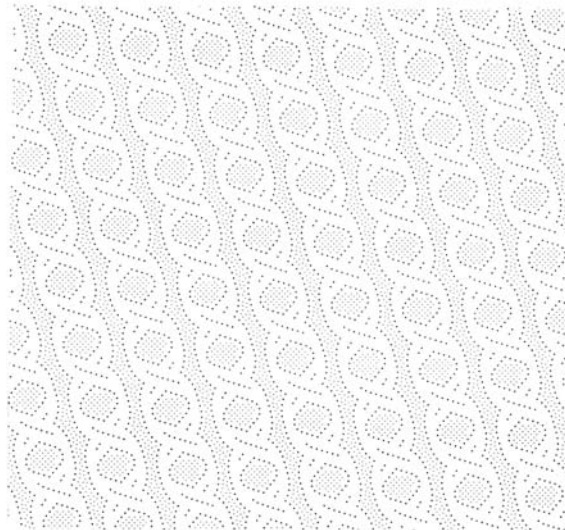

Produkt : Ornement for tørkepapir, klasse 5-06.
Innehaver : Georgia-Pacific France, 11, route Industrielle, F-68320 Kunheim, FR
Fullmektig: Oslo Patentkontor AS, Postboks 7007 Majorstua, 0306 Oslo, NO
Designer : Nicolas Pommier, 90, route d'Ingersheim, F-68000 Colmar og Joël Hungler, 15, rue des Longs Champs, Ingremare, F-27600 Ailly, begge FR

Reg.nr: 77705

Søkn.nr: 20030400

Inngitt: 2003.07.21

Allm. tilgj.: 2003.08.21

Reg.dato: 2004.01.28

Kunngjort: 2004.02.16

Reg. gjelder til: 2008.07.21

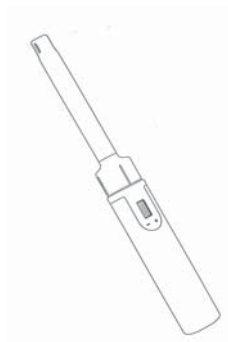

1.1



1.2



1.3



1.4

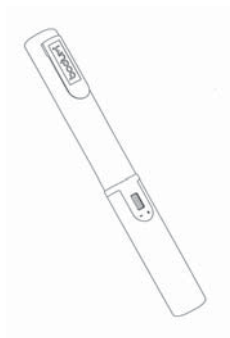

2.1

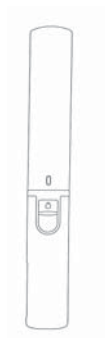

2.2



2.3



2.4

Produkter : 1. Lighter, 2. Lighter, klasse 27-05.
Innehaver : PI-Design AG, Kantonsstrasse 100, CH-6234 Triengen, CH
Fullmektig: Actio-Lassen AS, Postboks 1880 Nordnes, 5817 Bergen, NO
Designer : Jørgen Bodum, St Niklausenstrasse 23, CH-6005 St Niklausen, CH
Prioritet: 2003.02.21, DK, nr. 2003 00138.
Anmerkninger: Registreringen gjelder samregistrering.
Det er ikke foretatt supplerende undersøkelse.

Reg.nr: 77706

Søkn.nr: 20030438

Inngitt: 2003.08.12

Allm. tilgj.: 2004.01.28

Reg.dato: 2004.01.28

Kunngjort: 2004.02.16

Reg. gjelder til: 2008.08.12

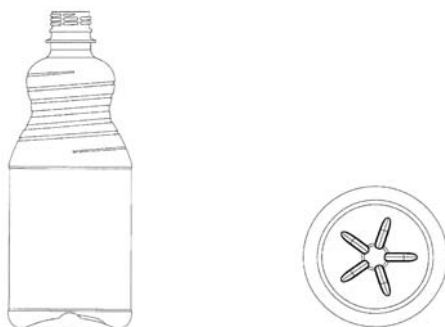

Produkt : Flaske, 9-01.

Innehaver : Stabburet AS, Postboks 711, 1411 Kolbotn, NO

Fullmektig: Oslo Patentkontor AS, Postboks 7007 Majorstua, 0306 Oslo, NO

Designer : Hedda Braathen, c/o Accendo Produktutvikling AS, Postboks 207 Skøyen, 0213 Oslo, NO

Anmerkning: Det er ikke foretatt supplerende undersøkelse.

Reg.nr: 77707

Søkn.nr: 20030446

Inngitt: 2003.08.18

Allm. tilgj.: 2004.01.28

Reg.dato: 2004.01.28

Kunngjort: 2004.02.16

Reg. gjelder til: 2008.08.18

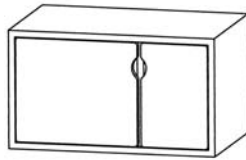

Produkt : Skapmodul, klasse 6-04.
Innehaver : Hans Joachim Kotthaus, Postboks 111, 4330 Ålgård, NO
Designer : Hans Joachim Kotthaus, Postboks 111, 4330 Ålgård, NO
Anmerkning: Det er ikke foretatt supplerende undersøkelse.

Reg.nr: 77708

Søkn.nr: 20030442

Inngitt: 2003.08.14

Allm. tilgj.: 2004.01.29

Reg.dato: 2004.01.29

Kunngjort: 2004.02.16

Reg. gjelder til: 2008.08.14



1.

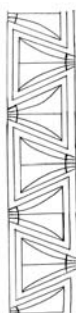

2.



3.

Produkt : 1. Ornamet til festdrakter, 2. Ornamet til festdrakter, 3. Ornamet til festdrakter, klasse 2-02.

Innehaver : Mette Wahlberg, Frøylandsveien 17, 4355 Kvernaland, NO

Designer : Rebekkaboden, Meierigaten 6, 4340 Bryne, NO

Anmerkning: Registreringen gjelder samregistrering.
Det er ikke foretatt supplerende undersøkelse.

Reg.nr: 77709

Søkn.nr: 20030430

Inngitt: 2003.08.06

Allm. tilgj.: 2003.08.06

Reg.dat0: 2004.01.29

Kunngjort: 2004.02.16

Reg. gjelder til: 2008.08.06

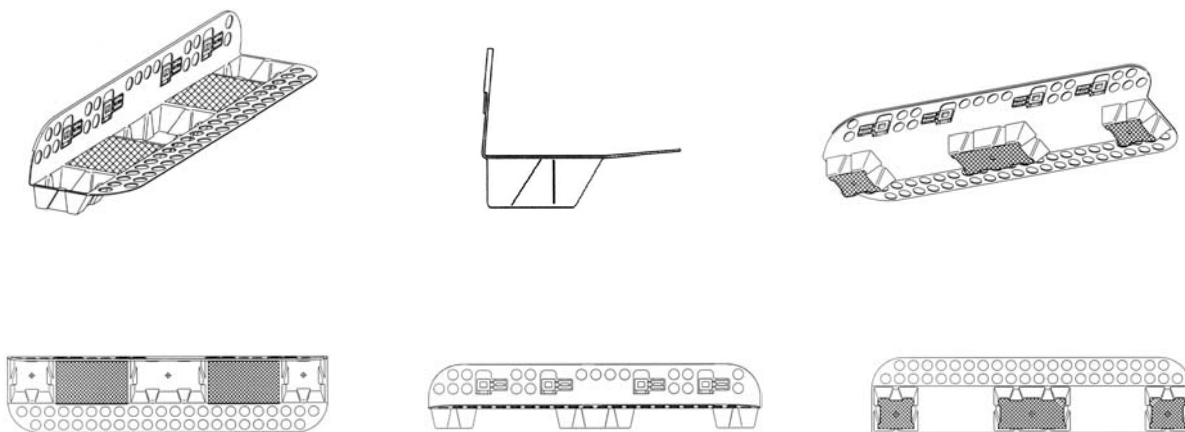

Produkt : Lastbeskyttelsesprofil, klasse 9-99.
Innehaver : Inter Ikea Systems BV, Olof Palmestraat 1, NL-2616 LN Delft, NL
Fullmektig: Onsagers AS, Postboks 6963 St Olavs Plass, 0130 Oslo, NO
Designer : Allan Dickner, Storkstigen 16, S-343 35 Älmhult, SE
Prioritet: 2003.02.11, SE, nr. 03-0191.
Anmerkning: Det er foretatt supplerende undersøkelse.

Reg.nr: 77711

Søkn.nr: 2002 0448

Inngitt: 2002.07.09

Allm. tilgj.: 2002.07.12

Reg.dat: 2004.01.29

Kunngjort: 2004.02.16

Reg. gjelder til: 2007.07.09



Produkt: Dusjenhet, klasse 23-02.

Innehaver: Hansgrohe AG, Auestr. 5-9, D-77761 Schiltach, DE

Fullmektig: Zacco Norway AS, Postboks 765 Sentrum, 0106 Oslo, NO

Designer: Andreas Dimitriadis, Am Mühlbach 10, D-73575 Leinzell, Tom Schönherr, Argonnenstrasse 22, D-70374 Stuttgart, Andreas Haug, Franklinstrasse 77, D-70435 Stuttgart, Peter Kolin, Galgenbergweg 6, D-73525 Schwäbisch Gmünd, alle DE

Prioritet: 2002.01.12, DE, 402 00 287.3.

Reg.nr: 77712

Søkn.nr: 2002 0509

Inngitt: 2002.08.13

Allm. tilgj.: 2002.10.16

Reg.dat0: 2004.01.29

Kunngjort: 2004.02.16

Reg. gjelder til: 2007.08.13



Produkt: Programmerbar dimmingsbryter, klasse 13-03.
Innehaver: Theben AG, Hohenbergstrasse 32, D-72401 Haigerloch, DE
Fullmektig: Curo AS, Postboks 38, 7231 Lundamo, NO
Designer: Christian von Boetticher, Baumäckerweg 1, D-72401 Haigerloch og Heike Locher, Rotdornweg 19, D-72393 Burladingen, begge DE
Prioritet: 2002.04.16, WO, DM/059 705.

Reg.nr: 77713

Søkn.nr: 2002 0513

Inngitt: 2002.08.19

Allm. tilgj.: 2002.08.20

Reg.dato: 2004.01.29

Kunngjort: 2004.02.16

Reg. gjelder til: 2007.08.19

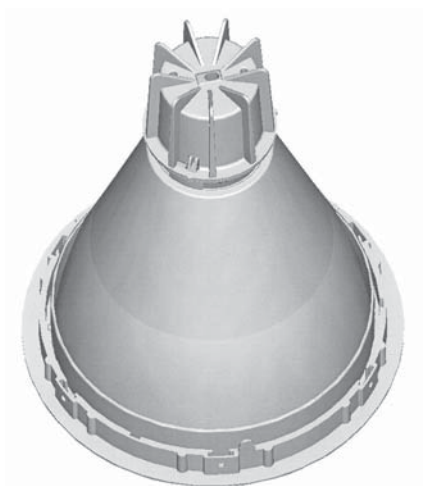

Produkt: Innfestingsanordning for taklampe, klasse 26-05.
Innehaver: Zumtobel Staff GmbH & Co KG, Grevenmarschstrasse 74-78, D-32657 Lemgo, DE
Fullmektig: Bryn Aarflot AS, Postboks 449 Sentrum, 0104 Oslo, NO
Designer: Chris Redfern, Viale Monte Nero 16, I-20135 Milano, IT
Prioritet: 2002.02.20, DE, 402 01 610.6.

Reg.nr: 77714

Søkn.nr: 2002 0527

Inngitt: 2002.08.23

Allm. tilgj.: 2002.08.27

Reg.dat0: 2004.01.29

Kunngjort: 2004.02.16

Reg. gjelder til: 2007.08.23

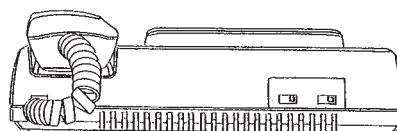
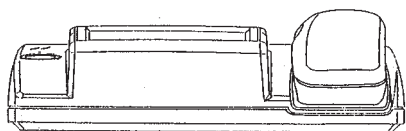
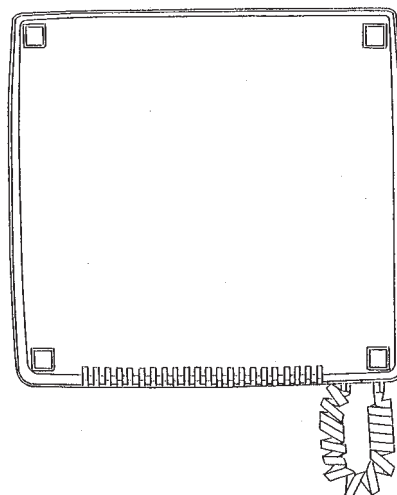
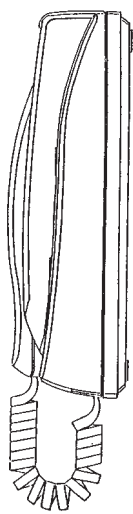
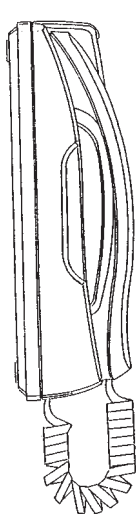
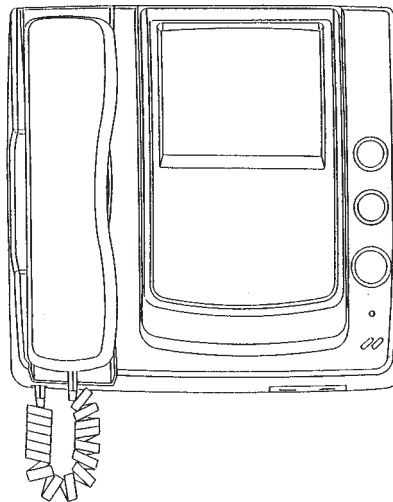
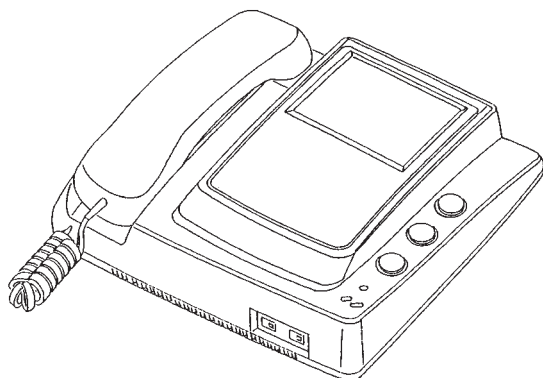

Produkt: Interntelefon, klasse 14-03.

Innehaver: Aiphone Co Ltd, 2-18 Jinno-Cho, Atsuta-ku, Nagoya-shi, Aichi-ken, JP

Fullmektig: Zacco Norway AS, Postboks 765 Sentrum, 0106 Oslo, NO

Designer: Manabu Yamada, c/o Aiphone Co Ltd, 2-18 Jinno-Cho, Atsuta-ku, Nagoya-shi, Aichi-ken og Toshio Hotta c/o COM-DESIGN Co Ltd, 12-107 Mitsuike, Kagiya-cho, Tokai-shi, Aichi-ken, begge JP

Prioritet: 2002.02.27, JP, nr 2002-5060.

Reg.nr: 77715

Søkn.nr: 2002 0774

Inngitt: 2002.12.16

Allm. tilgj.: 2003.06.16

Reg.dat0: 2004.01.29

Kunngjort: 2004.02.16

Reg. gjelder til: 2007.12.16



Produkt: Vest, klasse 2-02.

Innehaver: Marri Ann Galteland, Øvre Tingveg 12, 4735 Evje, NO

Fullmektig: Håmsø Patentbyrå ANS, Postboks 171, 4302 Sandnes, NO

Designer: Marri Ann Galteland, Øvre Tingveg 12, 4735 Evje, NO

Reg.nr: 77716

Søkn.nr: 2003 0125

Inngitt: 2003.02.28

Allm. tilgj.: 2003.02.28

Reg.dat0: 2004.01.29

Kunngjort: 2004.02.16

Reg. gjelder til: 2008.02.28

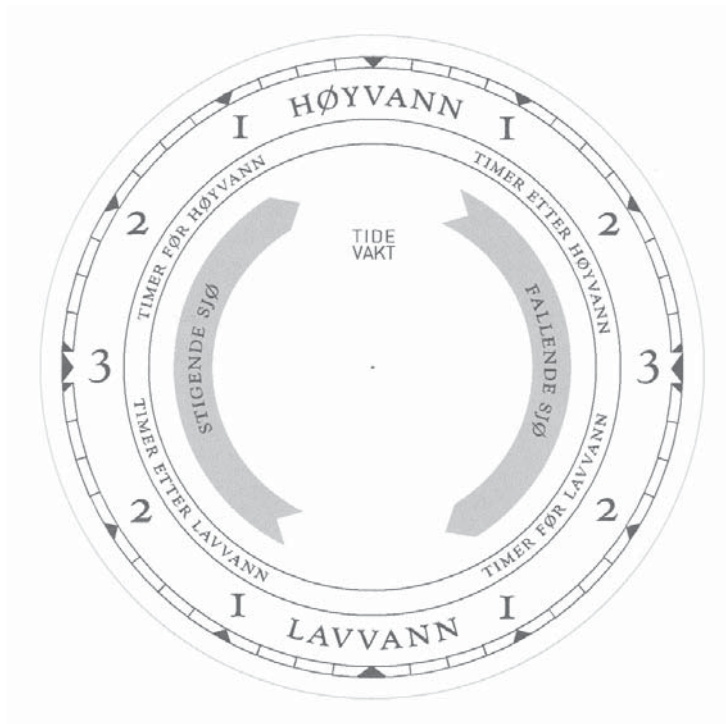

Produkt:

Urskive, klasse 10-03.

Innehaver:

Værdata Jan Aske Børresen, Prestegårdsveien 53, 0851 Oslo, NO

Designer:

Jan Aske Børresen, 7252 Dolmøy, NO

Fornyelse av registreringer

Reg.nr: 71816 Fornyhet til: 2009.01.13
Innehaver: Örebroskenan Aktiebolag, c/o Bengtsson, Spindelvägen 5, S-702 30 Örebro, SE
Fullmektig: ABC-Patent, Siviling. Rolf Chr. B. Larsen AS, Postboks 6150 Etterstad, 0602 Oslo, NO

Reg.nr: 71851 Fornyhet til: 2009.01.12
Innehaver: Koninklijke Philips Electronics NV, Groenewoudseweg 1, NL-5621 BA, Eindhoven, NL
Fullmektig: Zacco Norway AS, Postboks 765 Sentrum, 0106 Oslo, NO

Reg.nr: 71852 Fornyhet til: 2009.01.21
Innehaver: Continental Gislaved Däck AB, S-332 81 Gislaved, SE
Fullmektig: Onsagers AS, Postboks 6963 St Olavs Plass, 0130 Oslo, NO

Reg.nr: 71874 Fornyhet til: 2009.02.23
Innehaver: HTS Styling AS, Postboks 90, 3360 Geithus, NO
Fullmektig: Zacco Norway AS, Postboks 765 Sentrum, 0106 Oslo, NO

Reg.nr: 71910 Fornyhet til: 2009.02.10
Innehaver: CarnaudMetalbox plc, Woodside, Perry Wood Walk, Worcester, WR5 1EQ, GB
Fullmektig: Tandbergs Patentkontor AS, Postboks 7085 Majorstua, 0306 Oslo, NO

Reg.nr: 71911 Fornyhet til: 2009.02.10
Innehaver: CarnaudMetalbox plc, Woodside, Perry Wood Walk, Worcester, WR5 1EQ, GB
Fullmektig: Tandbergs Patentkontor AS, Postboks 7085 Majorstua, 0306 Oslo, NO

Reg.nr: 71922 Fornyhet til: 2009.02.21
Innehaver: Volvo AB, S-405 08 Göteborg, SE
Fullmektig: Zacco Norway AS, Postboks 765 Sentrum, 0106 Oslo, NO

Reg.nr: 71947 Fornyhet til: 2009.03.10
Innehaver: Fiskars Consumer OY AB, SF-10470 Fiskars, FI
Fullmektig: Pål Gulbrandsen i Bryn Aarflot AS, Postboks 449 Sentrum, 0104 Oslo, NO

Reg.nr: 71968 Fornyhet til: 2009.01.18
Innehaver: Unilever NV, Weena 455, NL-3013 AI Rotterdam, NL
Fullmektig: Kari O. Hanssen i Zacco Norway AS, Postboks 765 Sentrum, 0106 Oslo, NO

Reg.nr: 71971 Fornyhet til: 2009.02.03
Innehaver: Henkel Kommanditgesellschaft auf Aktien, D-40191 Düsseldorf, DE
Fullmektig: Kari O. Hanssen i Zacco Norway AS, Postboks 765 Sentrum, 0106 Oslo, NO

Rettelse

I Designtidende nr. 2/2004 ble reg.nr. 77673 kunngjort med kun én innehaver. Det skal være to:

BSH Bosch und Siemens Hausgeräte GmbH, Hochstrasse 17, D-81669 München, DE og
Porsche Design GmbH, Flugplatzstrasse 29, AT-5700 Zell am See, AT

Avgjørelser i innsigelser jf. mønsterloven § 21.

Reg.nr. 74790

Innehaver: Alf Gausereide, Odinsvei 17, 1472 Fjellhamar, NO

Innsiger: Ulefos Jernværk KS, 3830 Ulefoss, NO

Avgjørelse i Første avdeling: Registreringen opprettholdes.

Avgjørelse i Annen avdeling: Første avdelings avgjørelse stadfestes.