



Norsk

design tidende

www.patentstyret.no

Norsk designtidende er en publikasjon som inneholder kunngjøringer innenfor designområdet

BESØKSADRESSE

- ▶ Københavngaten 10

POSTADRESSE

- ▶ Postboks 8160 Dep.
0033 Oslo

E-POST mail@patentstyret.no

TELEFON

22 38 73 00

TELEFAKS

22 38 73 01

INFOSENTERETS TELEFONTID

kl. 09.00 - 15.00

- ▶ Telefon (+47) 22 38 73 33
- ▶ Telefax (+47) 22 38 73 31

Innholdsfortegnelse

Registrert design	side	3
Fornyelse av registreringer	»	36
Navnendringer	»	38

REGISTRERT DESIGN

I henhold til designloven § 18 første ledd i.f. kunngjøres i dag følgende registrerte design.

Det kan fremsettes krav om at designregistreringen helt eller delvis skal oppheves, jf designloven §§ 25 flg. og designforskriften §§ 26 flg.

Designregistreringen gjelder for den eller de periodene på fem år som søknaden er innlevert for, regnet fra søknadsdagen. Registreringen kan fornyes, jf designloven §§ 23 og 24. Maksimal beskyttelsestid er 25 år. For reservedeler, se unntaket i designloven § 23 annet ledd.

Reg.nr. : 78645
Søkn.nr. : 20030668
Inngitt : 2003.11.28
Allm. tilgj. : 2003.11.03
Registrert : 2005.04.08
Kunngjort : 2005.05.09
Reg. gjelder til : 2008.11.28

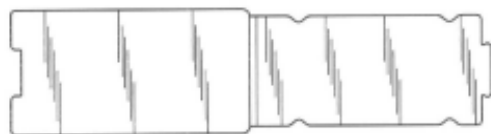

1.1

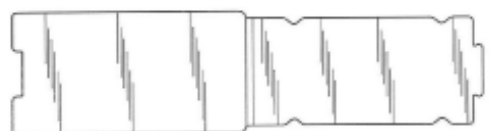

2.1



2.2



2.3

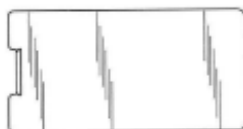

2.4



2.5



3.1

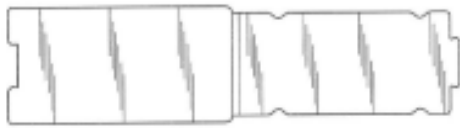

4.1



4.2



4.3



4.4



4.5



5.1



6.1



6.2

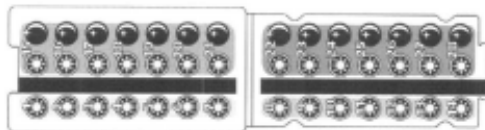

7.1



8.1



8.2



8.3



8.4



8.5



9.1



10.1



10.2

Produkt:

1. Forpakning
2. Forpakning
3. Forpakning
4. Forpakning
5. Forpakning
6. Forpakning
7. Forpakning
8. Forpakning
9. Forpakning
10. Forpakning

Klasse:

9-03

Innehaver:

Glaxo Group Ltd, Glaxo Wellcome House, Berkeley Avenue, UB60NN GREENFORD, MIDDLESEX, GB

Fullmektig:

Zacco Norway AS, Postboks 765 Sentrum, 0106 OSLO, NO

Designer:

Yvette Spencer, GlaxoSmithKline Park Road, Ware, SG120DP HERTFORDSHIRE, GB

Paul Richard Smith, c/o GlaxoSmithKline, Park Road, Ware, SG120DP HERTFORDSHIRE, GB

Peter David Walker, GlaxoSmithKline Park Road, Ware, SG120DP HERTFORDSHIRE, GB

Prioritet:

2003.05.03, EM, 00038344 (Designene 1,3,5,7 og 9)

Anmerkning:

Registreringen gjelder samregistrering.

Reg.nr. : 78646
Søkn.nr. : 20040096
Inngitt : 2004.03.04
Allm. tilgj. : 2004.05.14
Registrert : 2005.04.08
Kunngjort : 2005.05.09
Reg. gjelder til : 2009.03.04



1.1



1.2



1.3



1.4



1.5



1.6



1.7



2.1



2.2



2.3



2.4



2.5



2.6



2.7

Produkt: 1. Overvåkingskamera
2. Overvåkingskamera

Klasse: 16-01

Innehaver: Lidl Stiftung & Co KG, Stiftsbergstrasse 1, 74167 Neckarsulm, DE

Fullmektig: Zacco Norway AS, Postboks 765 Sentrum, 0106 OSLO, NO

Designer: Wing Wong, Unit 1405 Nanyang Plaza 57, Hung To Road, Kwun Tong, Kowloon, HONG KONG, CN

Prioritet: 2003.11.14, EM, 000107958

Anmerkning: Registreringen gjelder samregistrering.

Reg.nr. : 78647
Søkn.nr. : 20040337
Inngitt : 2004.06.17
Allm. Tilgj. : 2004.06.18
Registrert : 2005.04.08
Kunngjort : 2005.05.09
Reg. gjelder til : 2009.06.17

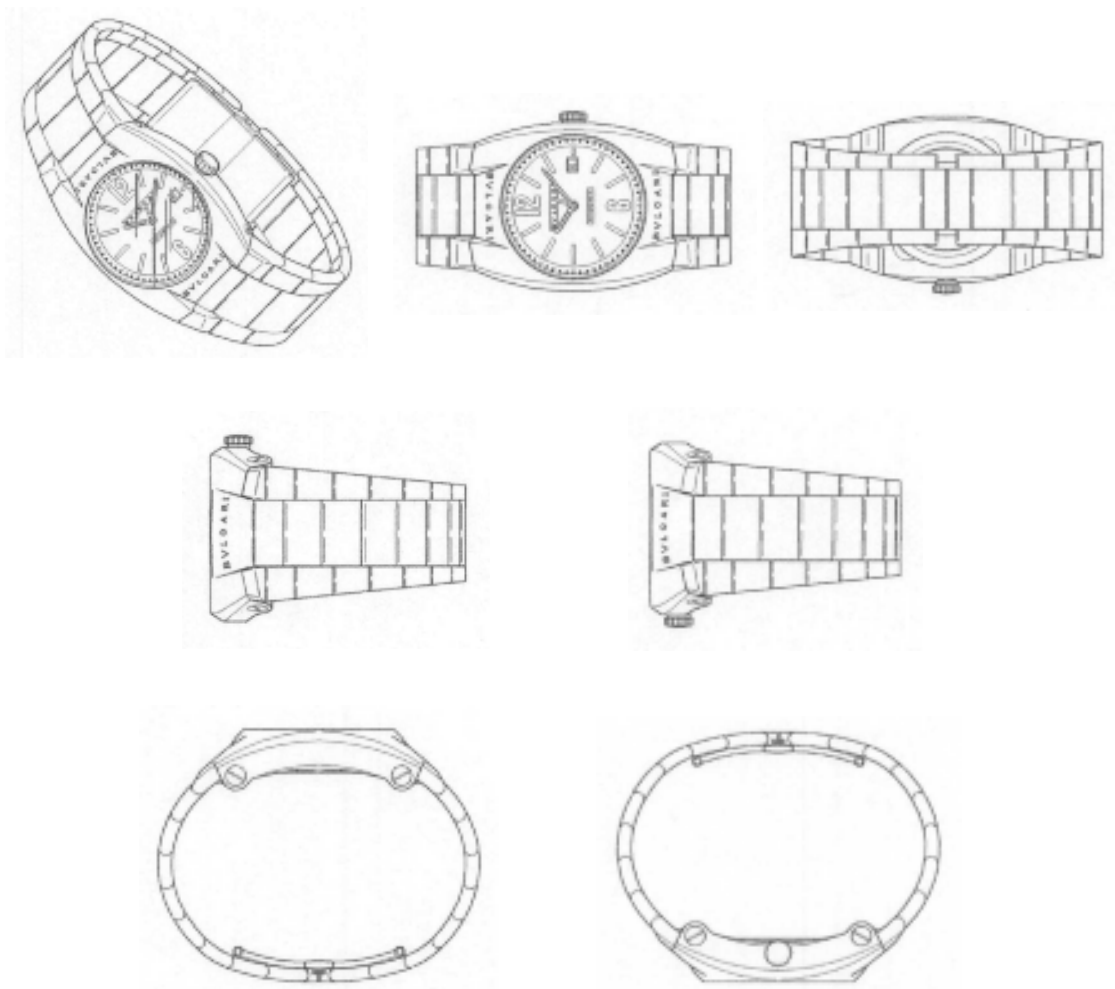

Produkt: Armbåndsur
Klasse: 10-02
Innehaver: Bulgari Time (Switzerland) SA, 34, Rue de Monruz, NEUCHATEL, CH
Fullmektig: Bryn Aarflot AS, Postboks 449 Sentrum, 0104 OSLO, NO
Designer: Paolo Bulgari, 10, Via Condotti, ROMA, IT
Prioritet: 2003.12.18, WO, 258189601
Anmerkning: Det er foretatt supplerende undersøkelse.

Reg.nr. : 78648
Søkn.nr. : 20030673
Inngitt : 2003.12.01
Allm. tilgj. : 2003.12.02
Registrert : 2005.04.11
Kunngjort : 2005.05.09
Reg. gjelder til : 2008.12.01

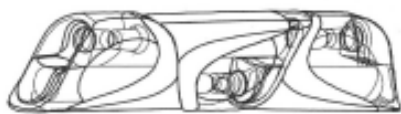

1.1



1.2



1.3



2.1



2.2



2.3

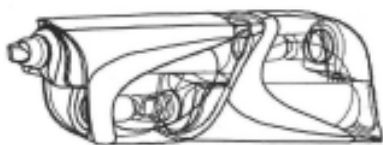

3.1



3.2



3.3

- Produkt:** 1. Trippelmerkepenn
2. Del til trippelmerkepenn
3. Del til trippelmerkepenn
- Klasse:** 19-06
- Innehaver:** Reynolds, 2, Place Edmond Regnault, 26000 VALENCE, FR
- Fullmektig:** Zacco Norway AS, Postboks 765 Sentrum, 0106 OSLO, NO
- Designer:** Philippe Banderet, 8, Le Clos Maria, Route du Stade, 26300 CHATUZANGE LE GOUBET, FR
- Prioritet:** 2003.06.02, FR, 032910
- Anmerkning:** Registreringen gjelder samregistrering

Reg.nr. : 78649
Søkn.nr. : 20050015
Inngitt : 2003.04.14
Allm. tilgj. : 2003.10.14
Registrert : 2005.04.11
Kunngjort : 2005.05.09
Reg. gjelder til : 2008.04.14





Produkt: Kaffemaskin
Klasse: 7-02
Innehaver: Société des Produits Nestlé SA , Case postale 353, 1800 VEVEY, CH
Fullmektig: Zacco Norway AS, Postboks 765 Sentrum, 0106 OSLO, NO
Designer: Antoine Cahen, Les Ateliers du Nord, Place du Nord 2, 1005 LAUSANNE, CH

Reg.nr. : 78650
Søkn.nr. : 20050016
Inngitt : 2003.04.14
Allm. tilgj. : 2003.10.14
Registrert : 2005.04.11
Kunngjort : 2005.05.09
Reg. gjelder til : 2008.04.14



Produkt: Kaffemaskin
Klasse: 7-02
Innehaver: Société des Produits Nestlé SA, Case postale 353, 1800 VEVEY, CH
Fullmektig: Zacco Norway AS, Postboks 765 Sentrum, 0106 OSLO, NO
Designer: Antoine Cahen, Les Ateliers du Nord, Place du Nord 2, 1005 LAUSANNE, CH
Anmerkning: Registreringen er en variant av reg. nr. 78652.

Reg.nr. : 78651
Søkn.nr. : 20050017
Inngitt : 2003.04.14
Allm. tilgj. : 2003.10.14
Registrert : 2005.04.11
Kunngjort : 2005.05.09
Reg. gjelder til : 2008.04.14





- Produkt:** Kaffemaskin
Klasse: 7-02
Innehaver: Société des Produits Nestlé SA, Case postale 353, 1800 VEVEY, CH
Fullmektig: Zacco Norway AS, Postboks 765 Sentrum, 0106 OSLO, NO
Designer: Antoine Cahen, Les Ateliers du Nord, Place du Nord 2, 1005 LAUSANNE, CH
Anmerkning: Registreringen er en variant av reg. nr. 78652.

Reg.nr. : 78652
Søkn.nr. : 20050018
Inngitt : 2003.04.14
Allm. tilgj. : 2003.10.14
Registrert : 2005.04.11
Kunngjort : 2005.05.09
Reg. gjelder til : 2008.04.14



Produkt: Kaffemaskin
Klasse: 7-02
Innehaver: Société des Produits Nestlé SA, Case postale 353, 1800 VEVEY, CH
Fullmektig: Zacco Norway AS, Postboks 765 Sentrum, 0106 OSLO, NO
Designer: Antoine Cahen, Les Ateliers du Nord, Place du Nord 2, 1005 LAUSANNE, CH
Anmerkning: Registreringen er en variant av reg. nr. 78650 og 78651.

Reg.nr. : 78653
Søkn.nr. : 20040095
Inngitt : 2004.03.04
Allm. tilgj. : 2004.03.04
Registrert : 2005.04.11
Kunngjort : 2005.05.09
Reg. gjelder til : 2009.03.04



1.1



1.2



Detaljutsnitt



2.1



3.1

- Produkt:** 1. Skilt til plakater
2. Skilt til plakater
3. Skilt til plakater
- Klasse:** 20-03
- Innehaver:** Paul Henry Roligheten, Rikard Nordraaks gate, Nord 10 A, 3722 SKIEN, NO
Marian Louise Starr, Rikard Nordraaks gate, Nord 10 A, 3722 SKIEN, NO
- Designer:** Paul Henry Roligheten, Rikard Nordraaks gate, Nord 10 A, 3722 SKIEN, NO
Marian Louise Starr, Rikard Nordraaks gate, Nord 10 A, 3722 SKIEN, NO
- Anmerkning:** Registreringen gjelder samregistrering

Reg.nr. : 78654
Søkn.nr. : 20040174
Inngitt : 2004.04.05
Allm. tilgj. : 2004.10.05
Registrert : 2005.04.11
Kunngjort : 2005.05.09
Reg. gjelder til : 2009.04.05

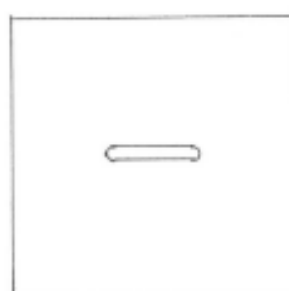
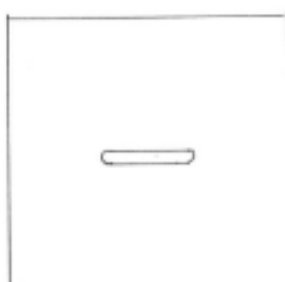
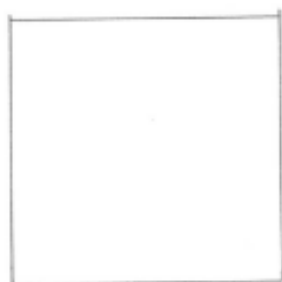
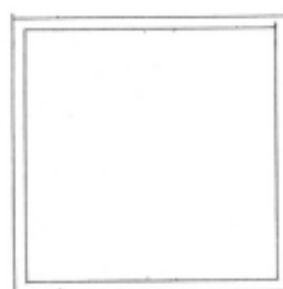
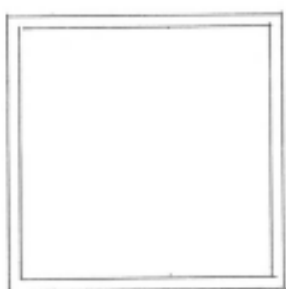

Produkt: Lekemøbel
Klasse: 6-06, 21-01
Innehaver: Magne Artur Veierød, Th.Lundesvei 5C, 2615 LILLEHAMMER, NO
Designer: Magne Artur Veierød, Th.Lundesvei 5C, 2615 LILLEHAMMER, NO

Reg.nr. : 78655
Søkn.nr. : 20040282
Inngitt : 2004.05.25
Allm. tilgj. : 2004.05.25
Registrert : 2005.04.11
Kunngjort : 2005.05.09
Reg. gjelder til : 2009.05.25



Produkt: Fjernstyrt leketøysfly
Klasse: 21-01
Innehaver: Nikko Co Ltd, 15-15, Kameari 5-chome, Katsushika-ku, 125-0061 TOKYO, JP
Fullmektig: Tandbergs Patentkontor AS, Postboks 7085 Majorstua, 0306 OSLO, NO
Designer: Shigeharu Sato, c/o Nikko Co Ltd, 15-15, Kameari 5-chome, Katsushika-ku, 125-0061 TOKYO, JP
Anmerkning: Designen er i farger.

Reg.nr. : 78656
Søkn.nr. : 20040283
Inngitt : 2004.05.25
Allm. tilgj. : 2004.05.25
Registrert : 2005.04.11
Kunngjort : 2005.05.09
Reg. gjelder til : 2009.05.25



Produkt: Fjernstyrt leketøysbil
Klasse: 21-01
Innehaver: Nikko Co Ltd, 15-15, Kameari 5-chome, Katsushika-ku, 125-0061 TOKYO, JP
Fullmektig: Tandbergs Patentkontor AS, Postboks 7085 Majorstua, 0306 OSLO, NO
Designer: Shigeharu Sato, c/o Nikko Co Ltd, 15-15, Kameari 5-chome, Katsushika-ku, 125-0061 TOKYO, JP
Anmerkning: Designen er i farger.

Reg.nr. : 78657
Søkn.nr. : 20040284
Inngitt : 2004.05.21
Allm. tilgj. : 2004.05.21
Registrert : 2005.04.12
Kunngjort : 2005.05.09
Reg. gjelder til : 2009.05.21

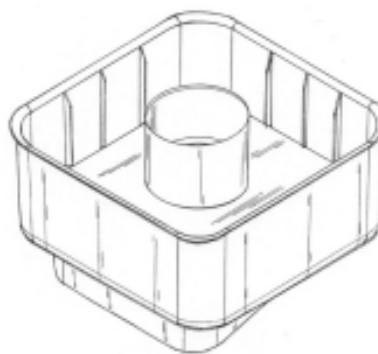
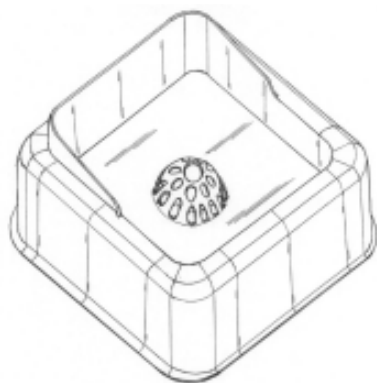

Produkt: Regnvannsbrønn
Klasse: 23-01
Innehaver: Meriser OY, Kauppatie 2, 29900 MERIKARVIA, FI
Fullmektig: Håmsø Patentbyrå ANS, Postboks 171, 4302 SANDNES, NO
Designer: Hannu Kuusinen, Lemmenrannantie, 29900 MERIKARVIA, FI

Reg.nr. : 78658
Søkn.nr. : 20030447
Inngitt : 2003.08.19
Allm. tilgj. : 2003.08.19
Registrert : 2005.04.12
Kunngjort : 2005.05.09
Reg. gjelder til : 2008.08.19



1.1



2.1



2.2



2.3



3.1



3.2



3.3

Produkt: 1. Låsedeksel med låselokk til gateboks
2. Låsedeksel til gateboks
3. Låselokk til gateboks

Klasse: 25-02

Innehaver: Helnor AS, Postboks 10, 2381 Brumunddal, NO

Designer: Helge Nordahl Hagen, Amerikaveien, 2350 Nes, NO

Anmerkning: Registreringen gjelder samregistrering.

Reg.nr. : 78659
Søkn.nr. : 20040164
Inngitt : 2004.03.31
Allm. tilgj. : 2004.03.31
Registrert : 2005.04.13
Kunngjort : 2005.05.09
Reg. gjelder til : 2009.03.31

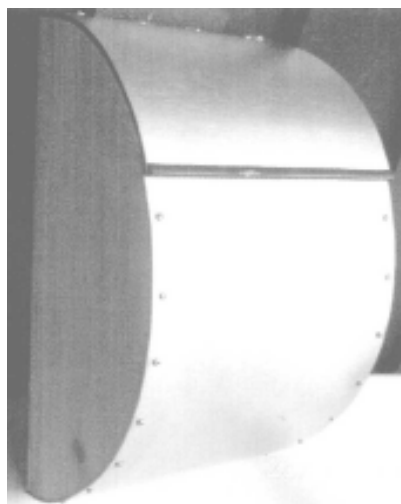
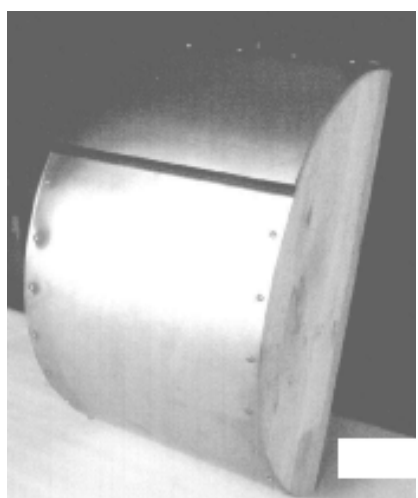
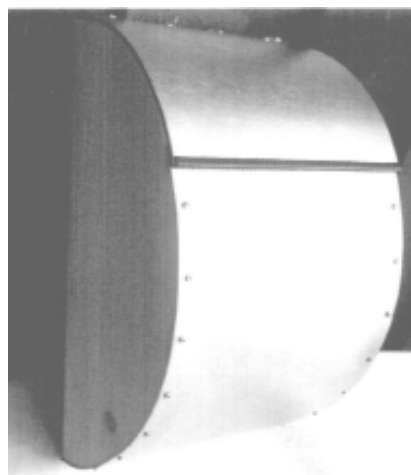
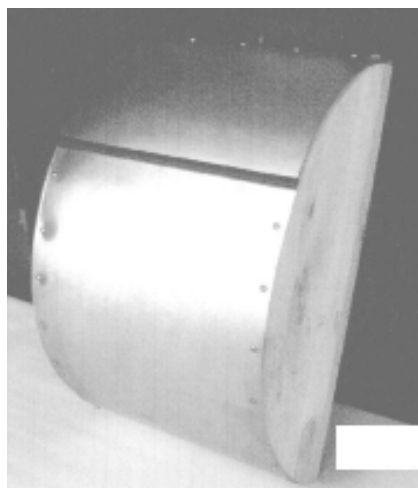

Produkt: Postkasse
Klasse: 25-03
Innehaver: Arne R H Eriksen, Svelvikgaten 8, 3117 TØNSBERG, NO
Designer: Arne R H Eriksen, Svelvikgaten 8, 3117 TØNSBERG, NO

Reg.nr. : 78660
Søkn.nr. : 20040121
Inngitt : 2004.03.12
Allm. tilgj. : 2004.03.12
Registrert : 2005.04.14
Kunngjort : 2005.05.09
Reg. gjelder til : 2009.03.12



1.1

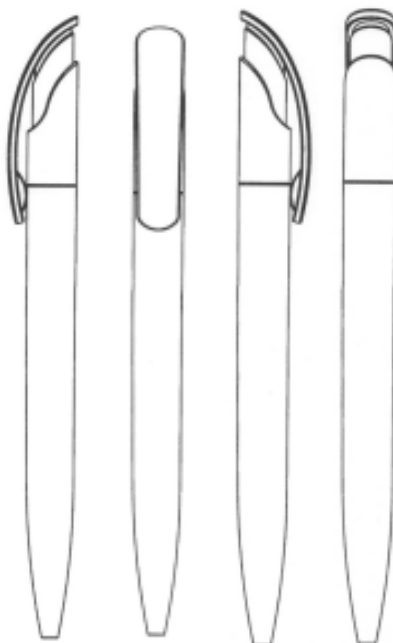

1.2

1.3

1.4

1.5



1.6

1.7

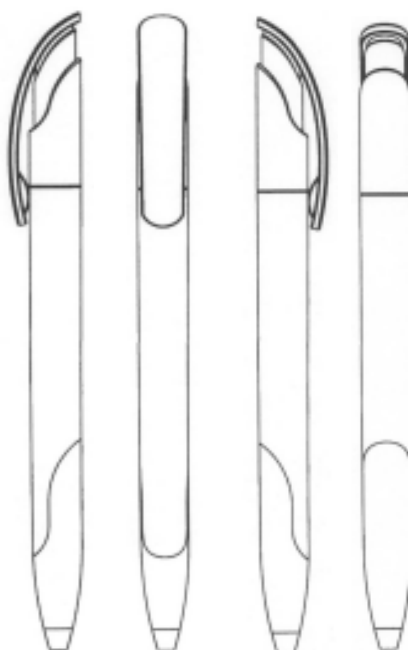

2.1

2.2

2.3

2.4



2.5



2.6

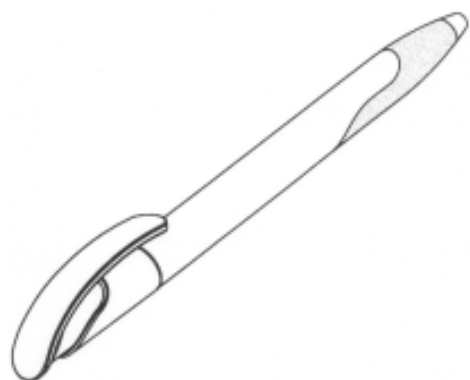

3.1



4.1

4.2

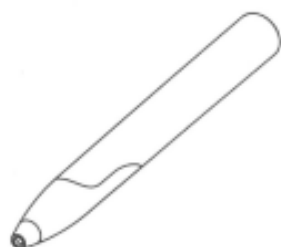

5.1

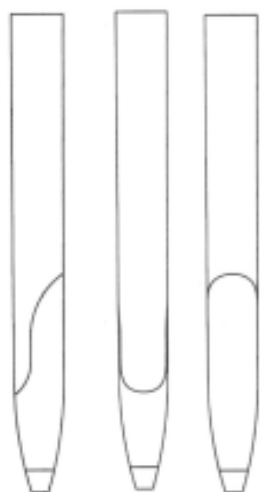

5.2

5.3

5.4

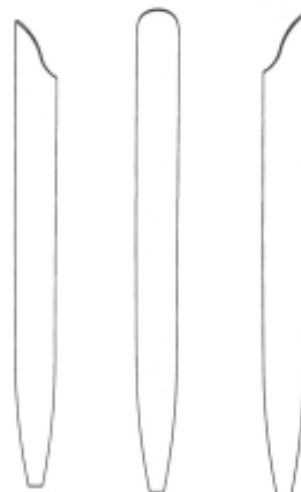

6.1

6.2

6.3

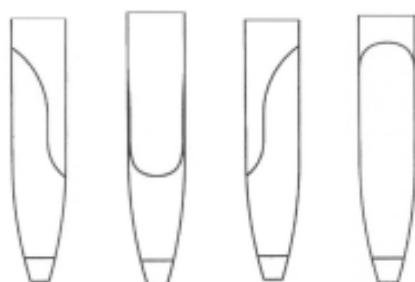

7.1

7.2

7.3

7.4



8.1



8.2



9.1



10.1



10.2



10.3



11.1



11.2



11.3



11.4

Produkt:

1. Skriveredskap
2. Skriveredskap
3. Skriveredskap
4. Skriveredskap
5. Del til skriveredskap
6. Del til skriveredskap
7. Del til skriveredskap
8. Del til skriveredskap
9. Del til skriveredskap
10. Del til skriveredskap
11. Del til skriveredskap

Klasse:

19-06

Innehaver:

Merz & Krell GmbH & Co KGaA, Bahnhofstrasse 76, 64401 Gross-Bieberau, DE

Fullmektig:

Onsagers AS, Postboks 6963 St Olavs Plass, 0130 Oslo, NO

Designer:

Volkmar Rommel, Am Strassdorfer Berg 1, 73529 Schwäbisch-Gmünd, DE

Prioritet:

2003.09.12, DE, 40306002

Anmerkning:

Registreringen gjelder samregistrering.

Reg.nr. : 78661
Søkn.nr. : 20030159
Inngitt : 2003.03.12
Allm. tilgj. : 2003.03.12
Registrert : 2005.04.14
Kunngjort : 2005.05.09
Reg. gjelder til : 2008.03.12

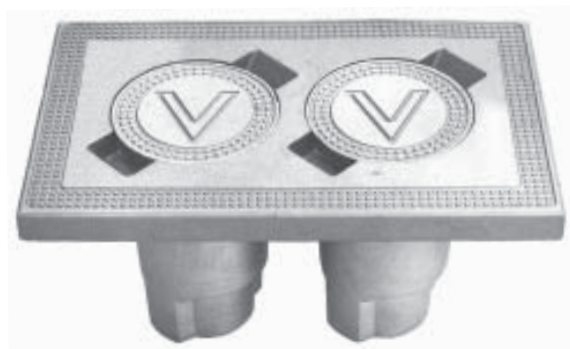

1.1

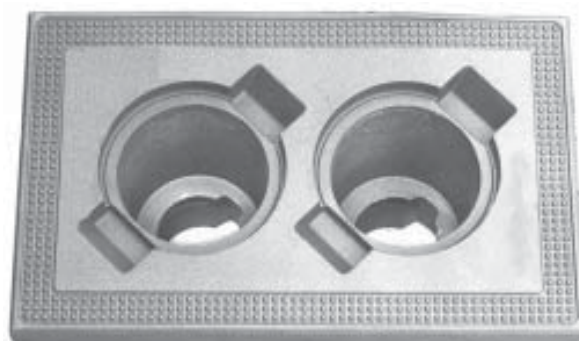

2.1

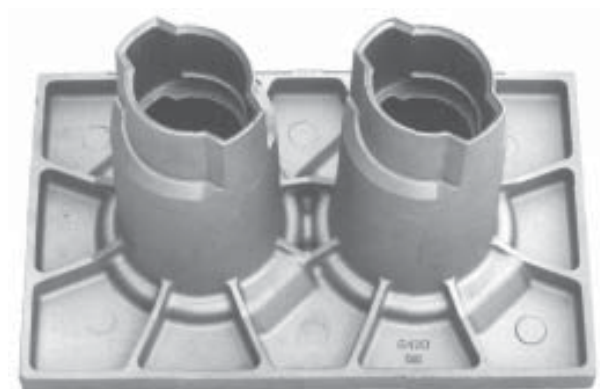

2.2



3.1



4.1



4.2

Produkt: 1. Gateboks
 2. Del til gateboks
 3. Del til gateboks
 4. Del til gateboks

Klasse: 25-02

Innehaver: Helnor AS, v/Helge Nordahl Hagen, Postboks 10, 2381 Brumunddal, NO

Designer: Helge Nordahl Hagen, Amerikavn., 2350 Nes, NO

Anmerkning: Registreringen gjelder samregistrering.

Reg.nr. : 78662
Søkn.nr. : 20040266
Inngitt : 2004.05.14
Allm. tilgj. : 2004.11.14
Registrert : 2005.04.15
Kunngjort : 2005.05.09
Reg. gjelder til : 2009.05.14

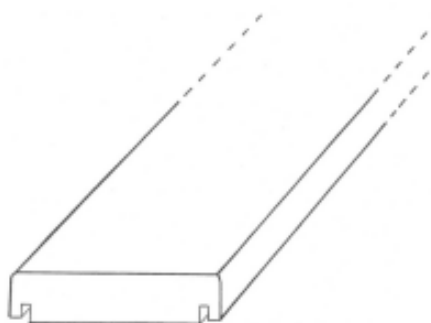

Produkt: Bord/plankeprofil
Klasse: 25-01
Innehaver: Mangs Netskar, Støttumveien 3, 1170 OSLO, NO
Fullmektig: Protector Intellectual Property Consultants AS, Postboks 5074 Majorstua, 0301 OSLO, NO
Designer: Mangs Netskar, Støttumveien 3, 1170 OSLO, NO
Anmerkning: Det er foretatt supplerende undersøkelse.

Reg.nr. : 78663
Søkn.nr. : 20030679
Inngitt : 2003.12.02
Allm. tilgj. : 2004.06.02
Registrert : 2005.04.20
Kunngjort : 2005.05.09
Reg. gjelder til : 2008.12.02



1.1



1.2



2.1



2.2



3.1



3.2



4.1



4.2

Produkt:
1. Festdrakt
2. Festdrakt
3. Festdrakt
4. Festdrakt

Klasse: 02-02

Innehaver: Helen Nguyen, Mellomveien 4 a, 7042 TRONDHEIM, NO

Designer: Helen Nguyen, Mellomveien 4 a, 7042 TRONDHEIM, NO

Anmerkning: Designene er i farger.
Registreringen gjelder samregistrering.

Reg.nr. : 78664
Søkn.nr. : 20040226
Inngitt : 2004.04.28
Allm. tilgj. : 2004.04.30
Registrert : 2005.04.20
Kunngjort : 2005.05.09
Reg. gjelder til : 2009.04.28

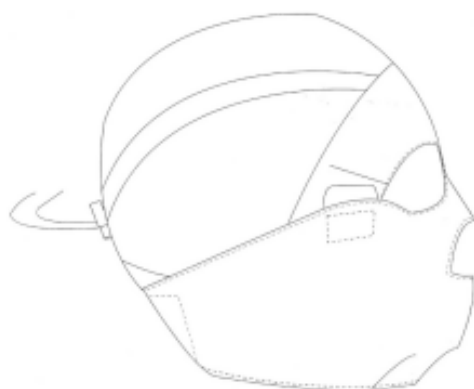
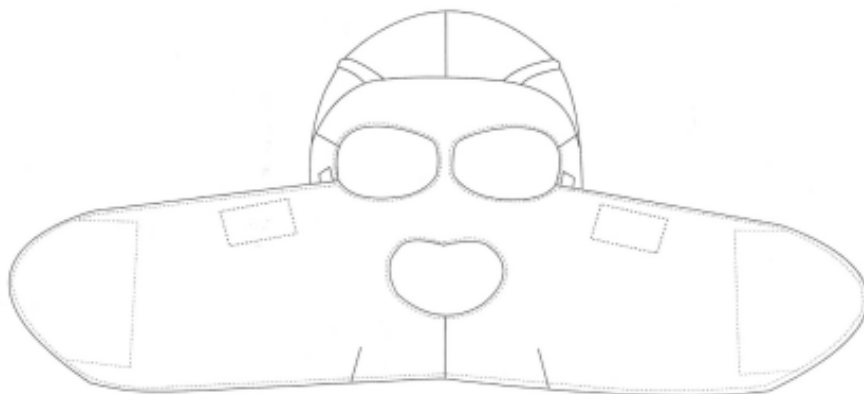

Produkt: Hodeplagg
Klasse: 2-03
Innehaver: Eleonora Königsson, Gävlegatan 7, 3 tr, 11330 STOCKHOLM, SE
Monika Söderberg, Grönviksvägen 10, 16771 BROMMA, SE
Designer: Eleonora Königsson, Gävlegatan 7, 113 30 STOCKHOLM, SE
Monika Söderberg, Grönviksvägen 10, 167 71 BROMMA, SE
Prioritet: 2003.10.30, SE, 030967

Reg.nr. : 78665
Søkn.nr. : 20040200
Inngitt : 2004.04.22
Allm. tilgj. : 2004.04.23
Registrert : 2005.04.20
Kunngjort : 2005.05.09
Reg. gjelder til : 2009.04.22



1.1

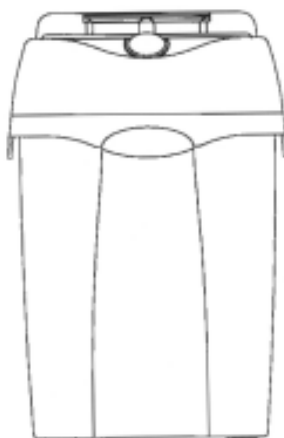

1.2



1.3

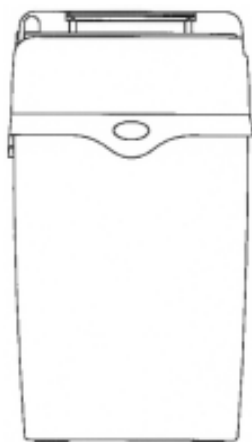

1.4

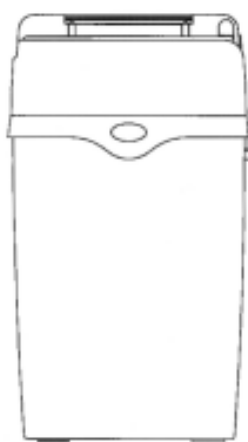

1.5



1.6



1.7



2.1

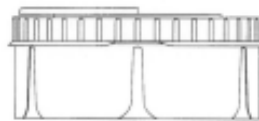

2.2



2.3



2.4

Produkt: 1. Avfallsbeholder
2. Kassettrinretning for avfallsbeholder

Klasse: 9-09

Innehaver: Sangenic International Ltd , Dudley Lane, Cramlington, NE237RH NORTHUMBERLAND, GB

Fullmektig: Tandbergs Patentkontor AS , Postboks 7085 Majorstua, 0306 OSLO, NO

Designer: Ian Alexander Webb, c/o Webb Scarlet, 12 Junction Mews, W21PN LONDON, GB
Mark Armstrong, c/o Webb Scarlet, 12 Junction Mews, W21PN LONDON, GB

Prioritet: 2003.10.23, EM, 000095468

Anmerkning: Registreringen gjelder samregistrering.

Navneendringer

Innehavers tidligere navn: Akzo Nobel Inks AB

Box 1003

231 25 TRELLEBORG

SE

Innehavers nåværende navn: ANI Printing Inks AB

Box 1003

231 25 TRELLEBORG

SE

Innehavers tidligere navn: Ackermann-Göggingen AG

München

DE

Innehavers nåværende navn: Ackermann Nähgarne GmbH & Co KG

Fabrikstr. 11

86199 AUGSBURG

DE

Innehavers tidligere navn: A.E. Stanley MFG CO

Decatur, IL

US

Innehavers nåværende navn: Tate & Lyle Ingredients Americas Inc

2200 E. Eldorado Street

IL62521 DECATUR

US

Innehavers tidligere navn: Comasec SA

Paris

FR

Innehavers nåværende navn: Comasec SAS

5, Allée des Bas Tilliers

92230 GENNEVILLIERS

FR

Innehavers tidligere navn: Metsäpuu OY

Puusepänkatu 1

SF-32200 Loimaa

FI

Innehavers nåværende navn: Domus Yhtiöt Oy

Puusepänkatu 1

Loimaa 32200

FI

Innehavers tidligere navn: Raison Tehtaat OY AB

Innehavers nåværende navn: Raisio Yhtymä OYJ

Innehavers tidligere navn: Danzas AG

Innehavers nåværende navn: Danzas Holding AG

Innehavers tidligere navn: Chanel SA

Innehavers nåværende navn: Chanel SarL

Innehavers tidligere navn; Weiders Farmasøytiske AS

Innehavers nåværende navn: Weifa AS

Innehavers tidligere navn: Boart International LTD
Innehavers nåværende navn Boart Longyear Ltd

Innehavers tidligere navn: Pharmacia AB
Innehavers nåværende navn : Pfizer Health AB

Innehavers tidligere navn: ZD Events Inc
Innehavers nåværende navn: MencdiaLive International Inc

Innehavers tidligere navn: Meadox Medicals, Inc
Innehavers nåværende navn: Boston Scientific Wayne Corp

Innehavers tidligere navn: V.S.H. Fabrieken BV
Innehavers nåværende navn: VSH Fittings BV

Tidligere innehavers navn: G.D. Searle & CO
Innehavers nåværende navn: G D Searle LLC

Innehavers tidligere navn: Behring Diagnostics GmbH
Innehavers nåværende navn: Dade Behring Marburg GmbH

Innehavers tidligere navn: Utro Arkaden AS
Innehavers nåværende navn: Utro Norge AS

Innehavers tidligere navn: Nordberg-Lokomo OY
Innehavers nåværende navn: Metso Minerals (Tampere) OY

Innehavers tidligere navn: Din Sko AB
Innehavers nåværende navn: Nilson Group AB

Innehavers tidligere navn: Sunbeam Corp
Innehavers nåværende navn: Sunbeam Products Inc

Innehavers tidligere navn: Inetfactory AS
Innehavers nåværende navn: Caves de Lisse AS

Innehavers tidligere navn: Weco DSB Travel AS
Innehavers nåværende navn: VIA Travel Danmark A/S

Innehavers tidligere navn: Zanders Feinpapiere AG
Innehavers nåværende navn: M-real Zanders GmbH

Innehavers tidligere navn: Stratec Medical AS
Innehavers nåværende navn: Synthes AS