

Procedures to File a Request to the CNIPA (China National Intellectual Property Administration) for Patent Prosecution Highway Pilot Program between the CNIPA and the NIPO (Norwegian Industrial Property Office)

The pilot period of this PPH pilot program will commence on 1 April, 2020 for duration of three years and ending on 31 March, 2023. The pilot period may be extended if necessary until the CNIPA and NIPO receive sufficient number of PPH requests to adequately assess the feasibility of PPH program.

The Offices may also terminate the PPH pilot program if the volume of participation exceeds manageable level, or for any other reason. Ex Ante notice will be published if the PPH pilot program is terminated.

PPH using the work products from the NIPO

Applicants can request accelerated examination by a prescribed procedure including submission of relevant documents on an application which is filed with the CNIPA and satisfies the following requirements under the CNIPA-NIPO Patent Prosecution Highway (PPH) pilot program based on the NIPO application.

When filing a request for the PPH pilot program, an applicant must submit a request form "Request for Participation in the Patent Prosecution Highway (PPH) Pilot Program" [PPH request] to the CNIPA.

1. Requirements

- (a) The CNIPA application (including PCT national phase application) is**
- (i) an application which validly claims priority under the Paris Convention to the NIPO application(s) (examples are provided in ANNEX I, Figures A, B, C, F, G and H), or**
 - (ii) a PCT national phase application without priority claim (an example is provided in Annex I, Figures I), or**
 - (iii) an application which validly claims priority under the Paris Convention to the PCT application(s) without priority claim (examples are provided in ANNEX I, Figures J, K and L).**

The CNIPA application, which validly claims priority to multiple NIPO or direct PCT applications, or which is the divisional application validly based on the originally filed

application that is included in (i) to (iii) above, is also eligible.

(b) *At least one corresponding application exists in the NIPO which has one or more claims that are determined to be patentable/allowable by the NIPO.*

The corresponding application(s) can be the application which forms the basis of the priority claim, an application which derived from the NIPO application which forms the basis of the priority claim (e.g., a divisional application of the NIPO application or an application which claims priority to the NIPO application (see Figure C in Annex I)), or an

NIPO regional phase application of a PCT application (see Figures H, I, J, K and L in Annex I).

Claims are “determined to be allowable/patentable” when the NIPO examiner explicitly identified the claims to be “allowable/patentable” in the latest office action, even if the application has not been granted yet.

Office actions mentioned above are:

"Godkjenning til meddelelse" (Decision to Grant),

“Uttalelse” or “Realitetsuttalelse” (Office action).

(c) *All claims in the CNIPA application (for which an accelerated examination under the PPH pilot program is requested), as originally filed or as amended, must sufficiently correspond to one or more of those claims determined to be patentable/allowable in the NIPO.*

Claims are considered to “sufficiently correspond” where, aside from differences due to translations and claim format, the claims in the CNIPA application are of the same or similar scope as the claims in the NIPO application, or the claims in the CNIPA are narrower in scope than the claims in the NIPO.

In this regard, a claim that is narrower in scope occurs when NIPO claim is amended to be further limited by an additional technical feature that is supported in the specification (description and/or claims).

A claim in the CNIPA which introduces a new/different category of claims to those claims determined to be patentable/allowable in the NIPO is not considered to sufficiently correspond. For example, if the NIPO claims only contain claims to a process of manufacturing a product, then the claims in the CNIPA are not considered to sufficiently correspond if the CNIPA claims introduce product claims that are dependent on the corresponding process claims.

It is not necessary to include “all” claims determined to be patentable/allowable in the NIPO in an application in the CNIPA (the deletion of claims is allowable). For example, in the case where an application in the NIPO contains 5 claims determined to be patentable/allowable, the application in the CNIPA may contain only 3 of these 5 claims.

Any claims amended or added after the grant of the request for participation in the PPH pilot program but before the CNIPA first office action must sufficiently correspond to the claims indicated as patentable/allowable in the NIPO application. Any claims amended or added after the first CNIPA office action need not to sufficiently correspond to the claims indicated as patentable/allowable by the NIPO when applicants need to amend claims in order to overcome the reasons for refusal raised by CNIPA examiners. Any amendment outside of the claim correspondence requirement is subject to examiners' discretion.

Note that any applicant to the CNIPA may amend the application including its claims on its or his own initiative when a request for substantive examination is made, and within the time limit of three months after the receipt of the *Notice of Invention Patent Application Entering into Substantive Examination Stage*. Therefore, an applicant needs to observe the time limit of amendment in order to make claims in the CNIPA application correspond to the claims determined to be patentable/allowable in the NIPO.

(d) *The CNIPA application must have been published.*

The applicant must have received the *Notice of Publication of Invention Patent Application* issued from the CNIPA before, or at the time of filing the PPH request.

(e) *The CNIPA application must have entered into substantive examination stage.*

The applicant must have received the *Notice of Invention Patent Application Entering into Substantive Examination Stage* issued from the CNIPA before, or at the time of filing the PPH request.

Note that as an exception, the applicant may file a PPH request simultaneously with the Request for Substantive Examination.

(f) *The CNIPA has not begun examination of the application at the time of filing the PPH request.*

The applicant should not have received any office action issued from the substantive examination departments in the CNIPA before, or at the time of filing the PPH request.

(g) *The CNIPA application must be electronic patent application.*

The applicant must convert the paper-based CNIPA application into electronic application before filing the PPH request.

2. Documents to be submitted

Documents (a) to (c) below must be submitted by attaching to "Request for Participation in the Patent Prosecution Highway (PPH) Pilot Program".

Note that even when it is not needed to submit certain documents below, the name of the documents must be listed in the “Request for Participation in the Patent Prosecution Highway (PPH) Pilot Program” (Please refer to the example form below for the details).

(a) Copies of all office actions (which are relevant to substantial examination for patentability in the NIPO) which were issued for the corresponding application by the NIPO, and translations thereof.

Either Chinese or English is acceptable as translation language. Machine translation will be admissible. If it is impossible for the examiner to understand the translated office action due to insufficient translation, the examiner can request the applicant to resubmit translations.

(b) Copies of all claims determined to be patentable/allowable by the NIPO, and translations thereof.

Either Chinese or English is acceptable as translation language. If it is impossible for the examiner to understand the translated claims, the examiner can request the applicant to resubmit translations.

(c) Copies of references cited by the NIPO examiner

The documents to be submitted are those cited in the above-mentioned office actions. Documents which are only referred to as references and consequently do not constitute reason for refusal do not have to be submitted.

If the references are patent documents, the applicant does not have to submit them¹. When the CNIPA does not possess the patent document, the applicant has to submit the patent document at the examiner’s request. Non-patent literature must always be submitted. The translations of the references are unnecessary.

When the applicant has already submitted above documents (a) to (c) to the CNIPA through simultaneous or past procedures, the applicant may incorporate the documents by reference and does not have to attach them.

3. Example of “Request for Participation in the Patent Prosecution Highway (PPH) Pilot Program” for filing request of an accelerated examination under the PPH pilot program

¹ Note that even when it is not needed to submit copies of references, the name of the references must be listed in the “Request for Participation in the Patent Prosecution Highway (PPH) Pilot Program”.

(a) Circumstances

When an applicant files a request for an accelerated examination under the PPH pilot program to the CNIPA, the applicant must submit a request form “Request for Participation in the Patent Prosecution Highway (PPH) Pilot Program”.

The applicant must indicate that the application is included in (i) to (iii) of 1. (a), and that accelerated examination is requested under the PPH pilot program. The application number, publication number, or a patent number of the corresponding NIPO application(s) must also be indicated.

Where the application with one or more claims determined to be patentable/allowable is different from the NIPO application(s) included in (i) to (iii) of 1. (a) (for example, the divisional application of the basic application), the application number, publication number, or a patent number of the application(s) which has claims determined to be patentable/allowable and the relationship between those applications must also be explained.

(b) Documents to be submitted

The applicant must list all required documents mentioned in point 2. above in an identifiable way, even when the applicant is exempted from submitting certain documents.

(c) Claim correspondence

The applicant requesting PPH must indicate in section D of the “Request for Participation in the Patent Prosecution Highway (PPH) Pilot Program” how all claims in the CNIPA application sufficiently correspond to the patentable/allowable claims in the NIPO application.

When claims are just literal translations of each other, the applicant can just enter “they are the same” in the table. When claims are not just literal translations, it is necessary to explain the sufficient correspondence of each claim based on the criteria 1.(c) (Please refer to the sample form below).

(d) Notice

An applicant can file the “Request for Participation in the Patent Prosecution Highway (PPH) Pilot Program” to the CNIPA through on-line procedures only.

4. Procedure for the accelerated examination under the PPH pilot program

The CNIPA decides whether the application can be entitled to the status for an accelerated examination under the PPH when it receives a request with the documents stated above. When

the CNIPA decides that the request is acceptable, the application is assigned a special status for an accelerated examination under the PPH.

In those instances where the request does not meet all the requirements set forth above, the applicant will be notified and the defects in the request will be identified. The applicant may be given opportunity, one time only, to correct certain specified defects. If the request is not approved, the applicant may resubmit the request up to one time. If the resubmitted request is still not approved, the applicant will be notified and the application will await action in its regular turn.

Sample Form

参与专利审查高速路（PPH）试点项目请求表

PPH

Request for participation in the Patent Prosecution Highway (PPH) Pilot Program (Sample Form)

A. 著录数据	
申请号	
B. 请求	
申请人请求参与专利审查高速路（PPH）试点项目基于：	
在先审查局（OEE）	
OEE 工作结果类型	<input type="checkbox"/> 国家/地区的审查意见
	<input type="checkbox"/> WO-ISA, WO-IPEA 或 IPER
OEE 申请号	
本申请与 OEE 申请的关系	
C. 文件提交	
第 I 栏 OEE 工作结果及其所需译文	
1.	<input type="checkbox"/> 提交了 OEE 工作结果的副本 <input type="checkbox"/> 请求通过案卷访问系统或 PATENTSCOPE 获取上述文件
2.	<input type="checkbox"/> 提交了 1 之所述文件的译文 <input type="checkbox"/> 请求通过案卷访问系统或 PATENTSCOPE 获取上述文件
第 II 栏 OEE 认定为可授权的所有权利要求的副本及其所需译文	
3.	<input type="checkbox"/> 提交了 OEE 认定为可授权的所有权利要求的副本 <input type="checkbox"/> 请求通过案卷访问系统或 PATENTSCOPE 获取上述文件
4.	<input type="checkbox"/> 提交了 3 之所述文件的译文 <input type="checkbox"/> 请求通过案卷访问系统或 PATENTSCOPE 获取上述文件
第 III 栏 OEE 工作结果引用的文件	
5.	<input type="checkbox"/> 提交了 OEE 工作结果引用的所有文件的副本（专利文献除外） <input type="checkbox"/> 无引用文件
第 IV 栏 已提交文件	
6.	<input type="checkbox"/> 若上述某些文件已经提交，请予说明： 申请人于__年__月__日在 CN_____中提交了_____文件

ANNEX I

A

A case meeting requirement (a) (i)
- Paris route -

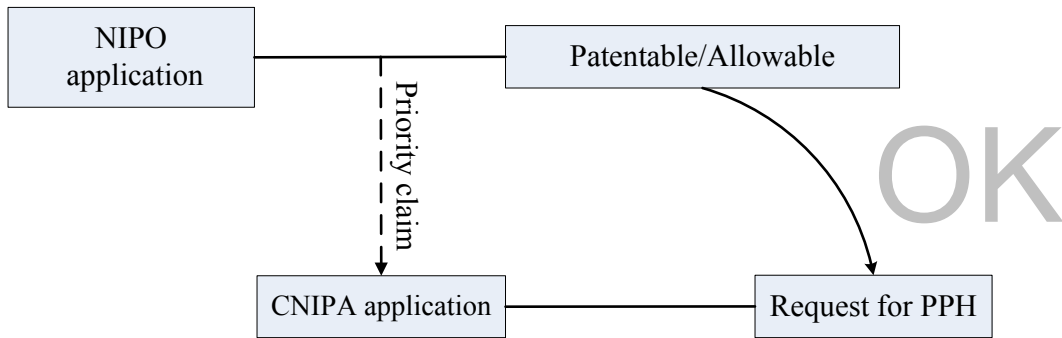

B

A case meeting requirement (a) (i)
- PCT route -

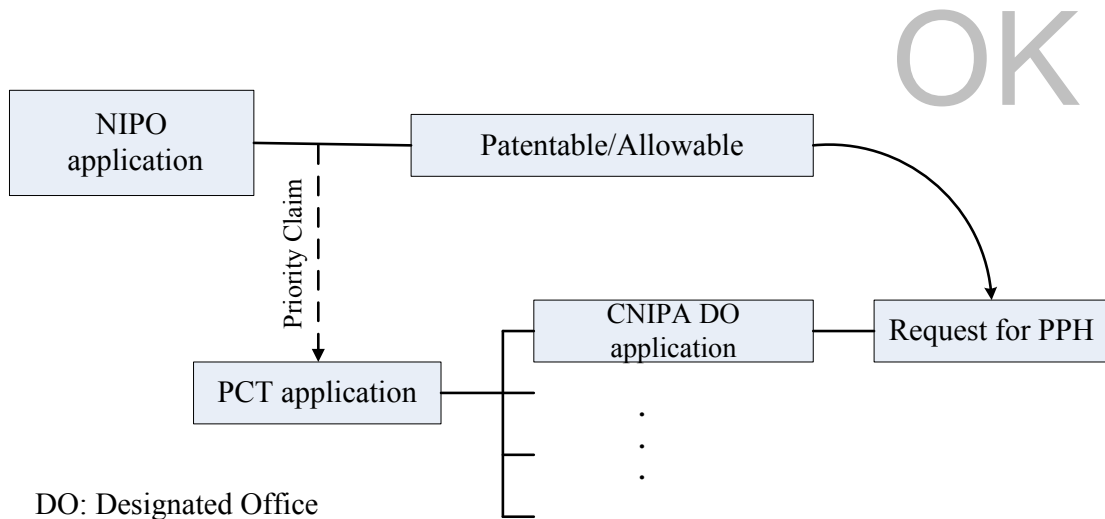

C

A case meeting requirement (a) (i)
- Paris route, Domestic priority -

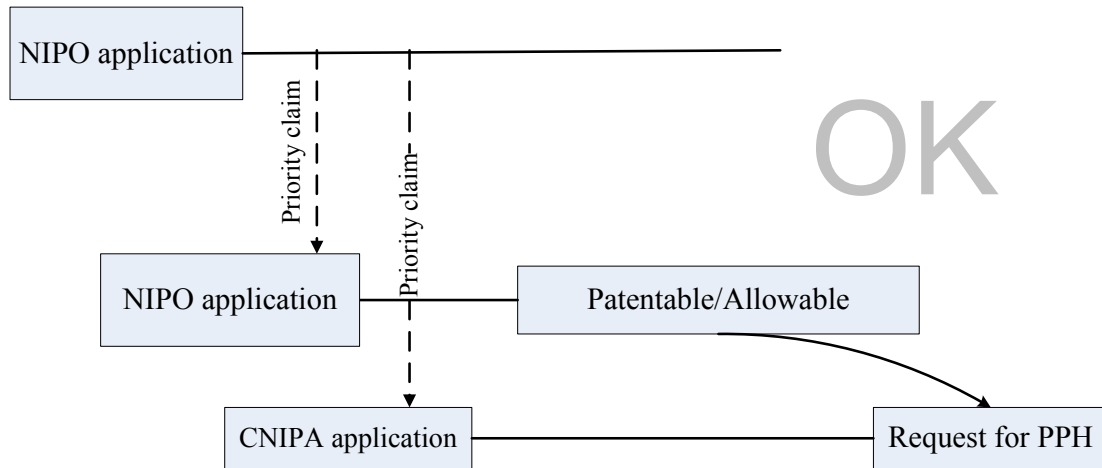

D

A case not meeting requirement (a)
- Paris route, but the first application is from the third office -

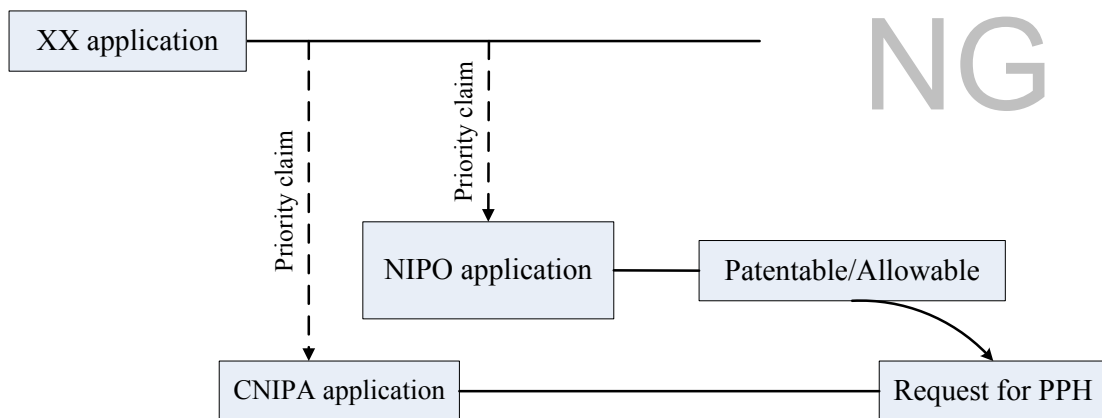

XX: the office other than the NIPO

E

A case not meeting requirement (a)
- PCT route, but the first application is from the third office -

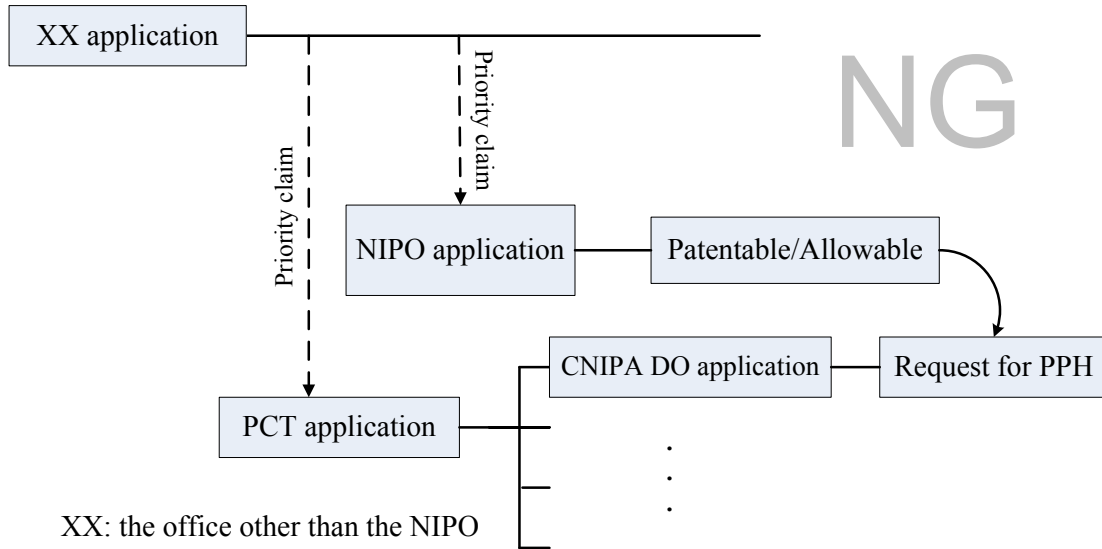

F

A case meeting requirement (a) (i)
- Paris route & complex priority -

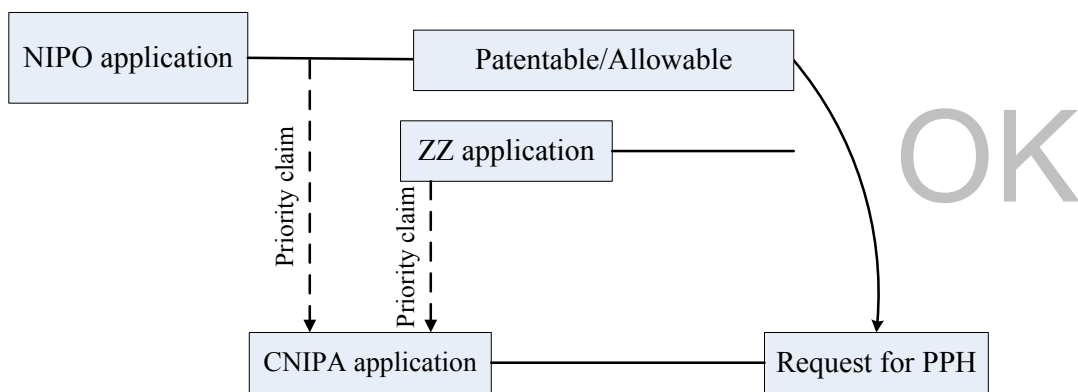

ZZ: any office

(The first application is from the NIPO)

G

A case meeting requirement (a) (i)
- Paris route & divisional application -

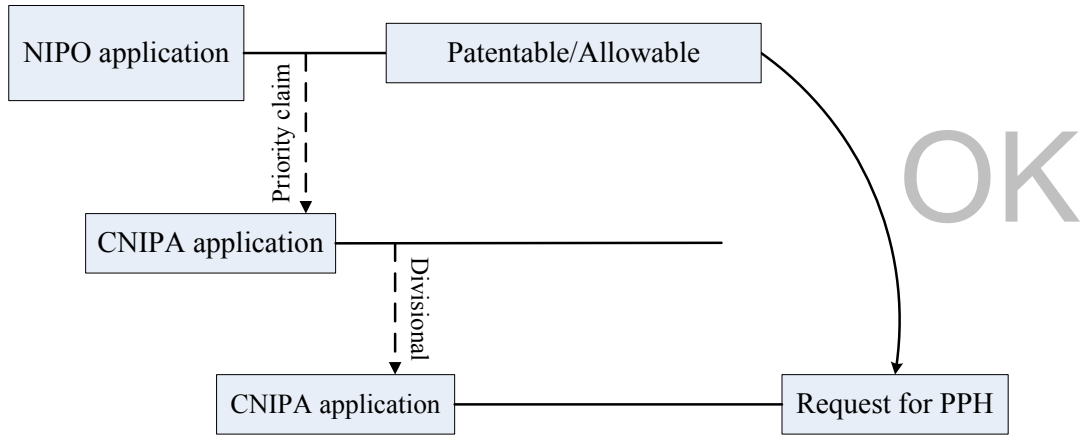

H

A case meeting requirement (a) (i)
- PCT route -

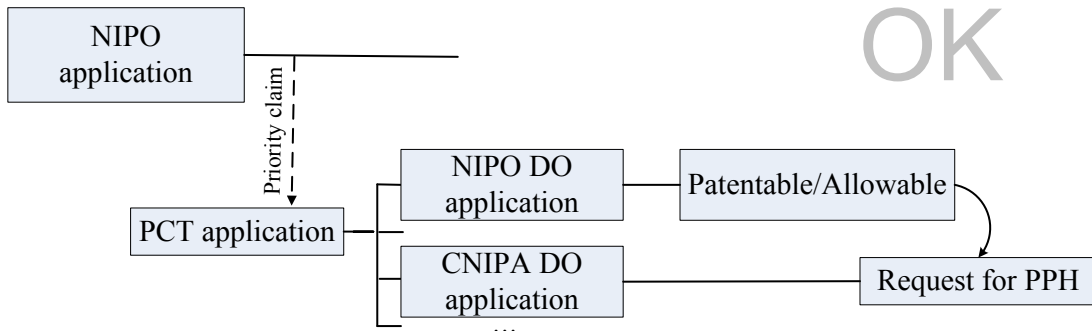

I

A case meeting requirement (a) (ii)
- Direct PCT route -

OK

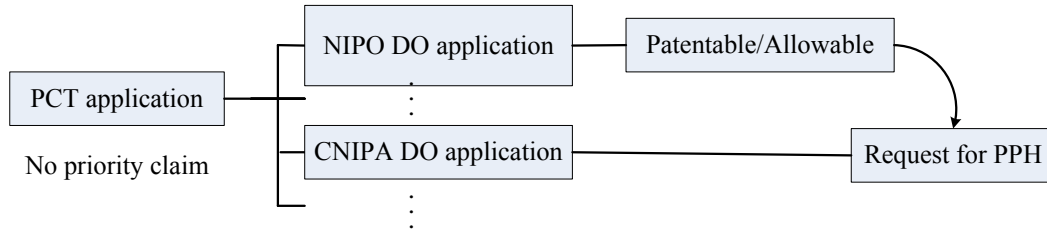

J

A case meeting requirement (a) (iii)
- Direct PCT & Paris route -

OK

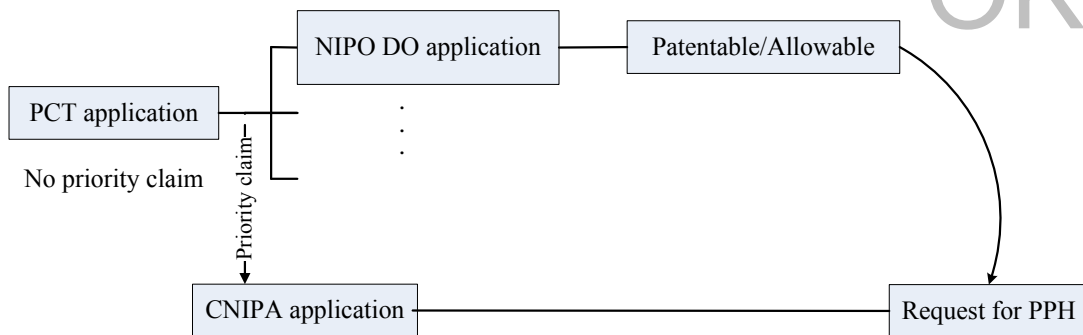

K

A case meeting requirement (a) (iii)
- Direct PCT & PCT route -

OK

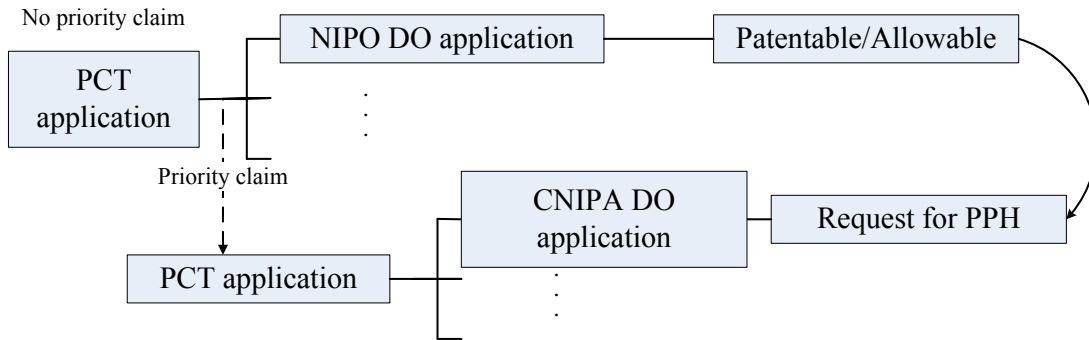

L

A case meeting requirement (a) (iii)
- Direct PCT & PCT route -

OK

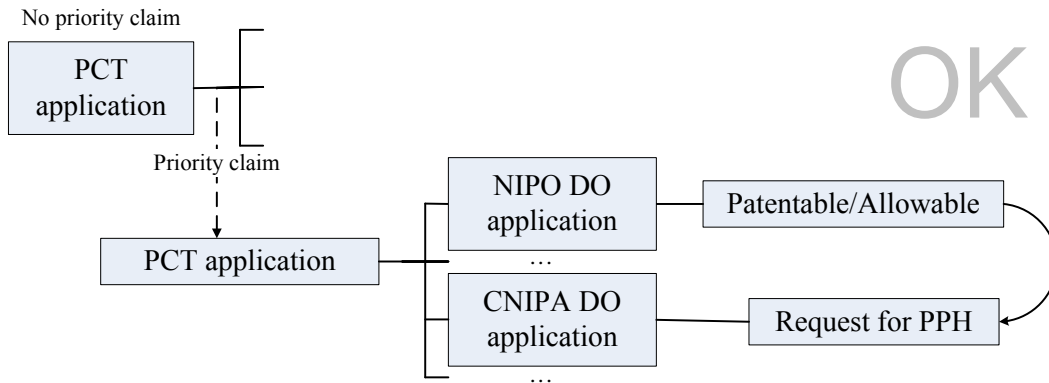

M

A case not meeting requirement (f)
- Examination has begun before a request for PPH -

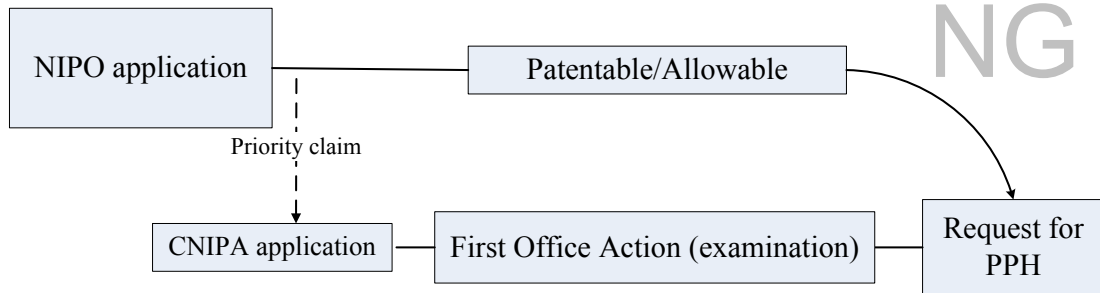

N

A case not meeting requirement (d)
- The application has not been published at the time of request for PPH -

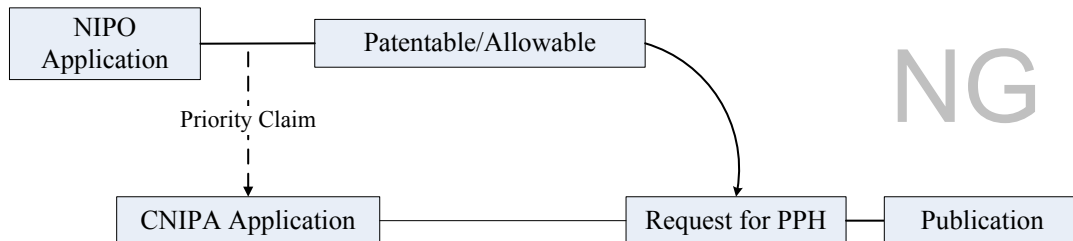

O

A case not meeting requirement (e)
- The application has not entered into substantive examination stage at the time of request for PPH -

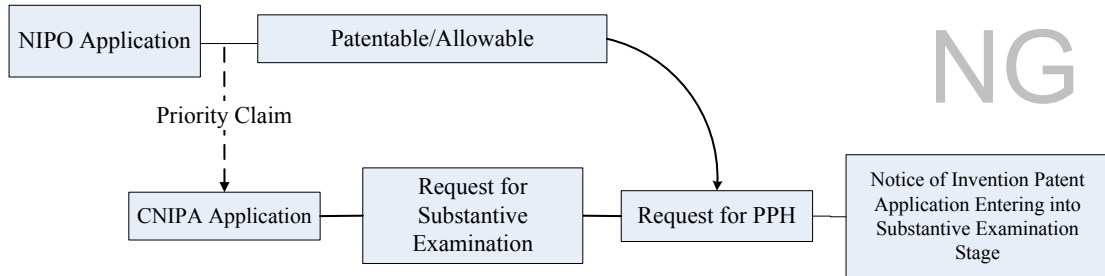

P

A case meeting requirement (e) (exception)
- PPH request simultaneously with the Request for Substantive Examination -

